

Isometric view

REV	DATE	DESCRIPTION
00	28JUL2020	INITIAL REVISION

- NOTES:
- (⊥) ALL VERTICAL SUPPORTS ARE PERPENDICULAR.
 - FLATNESS OF .5MM IS APPLIED BY DEFAULT.
 - ⊲ WELD BEAD OF 2MM RADIUS IS FOLLOWED.
 - ▽ SURFACE FINISH MEDIUM TO SMOOTH IS USED.
 - ALL TUBES ARE AS PER APL APOLLO STANDARD. CHANGES MAY EFFECT THE LOAD CAPACITY.
 - ALL HORIZONTAL AND VERTICAL TUBES ARE PERPENDICULAR TO EACH OTHER WITH ±1 DEG.
 - FINE WELDING IS REQUIRED AS PER MENTIONED DETAILS AND FINISHING.
 - HIGHER CURRENT WELDING MAY AFFECT THE BRITTLENESS OF MATERIAL WHICH LATER MAY RAISE TO WEAKENING OF STRUCTURE.
 - FABRICATORS ARE ALLOWED TO USE FITTINGS/FRAMES/SUPPORTS AS NEEDED AND THE SAME MUST BE COMMUNICATED BACK TO ENGINEERING TEAM.
 - BOP COMPONENT WEIGHTS ARE FOR REFERENCE ONLY AND SUBJECTED TO CHANGE PER PURCHASED COMPONENTS.

ITEM NO.	PART NUMBER	DESCRIPTION	QTY.	Wt (Kg) /Each
6	PLASTIC FITTINGS-BOP 2	----	2	----
5	PLASTIC FITTINGS-BOP 1	----	6	---
4	PLANK 1	250 X 25 X 1.6 X 500	2	3.42
3	TUBE 3	DIA 21.4 X 2 X AS REQUIRED	1	0.77
2	TUBE 2	DIA 21.4 X 2 X AS REQUIRED	1	1.51
1	TUBE 1	DIA 21.4 X 2 X AS REQUIRED	1	1.24

This drawing is our property. It can't be reproduced or communicated without our written agreement.

APL APOLLO TUBES LTD. 

DRAWING TITLE: **MINI STUDY TABLE**

DRAWN BY: SB	DATE: 28JUL2020	SIZE: A0	DRAWING NUMBER: P2P MINI STUDY TABLE	REV: 00
CHECKED BY: P2P Analysis & Solutions	DATE: 28JUL2020	SCALE: As Indicated	WEIGHT (kg): 0kg	SHEET 1 OF 3
DESIGNED BY: P2P Analysis & Solutions	DATE: 28JUL2020			

UNLESS OTHERWISE SPECIFIED DIMENSION ARE IN MM
 VIEWS: THIRD ANGLE PROJECTION

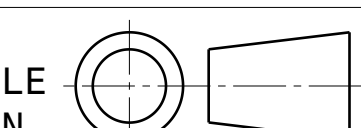

REV	DATE	DESCRIPTION
00	28JUL2020	INITIAL REVISION

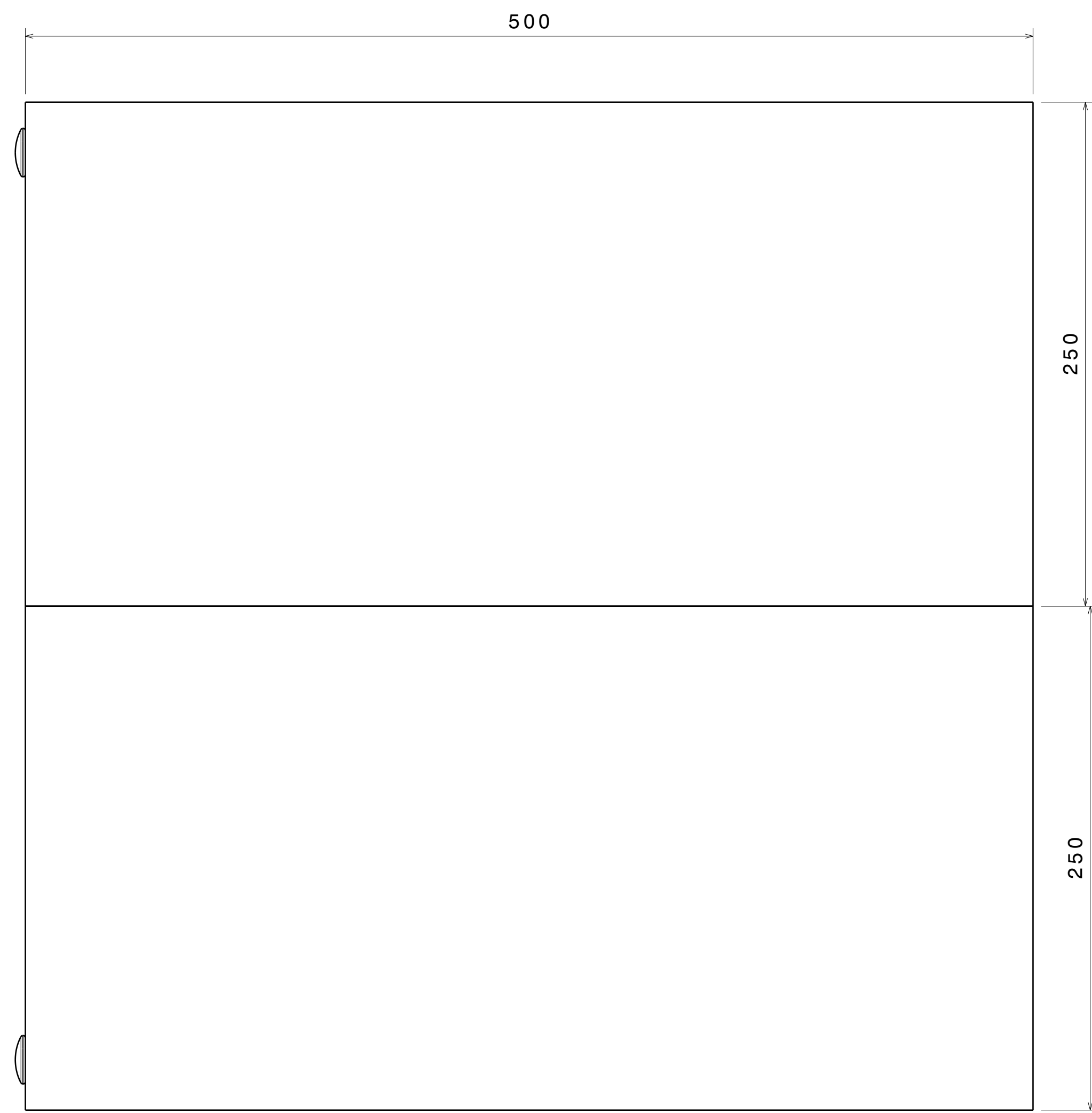

Top view
Scale: 1:2

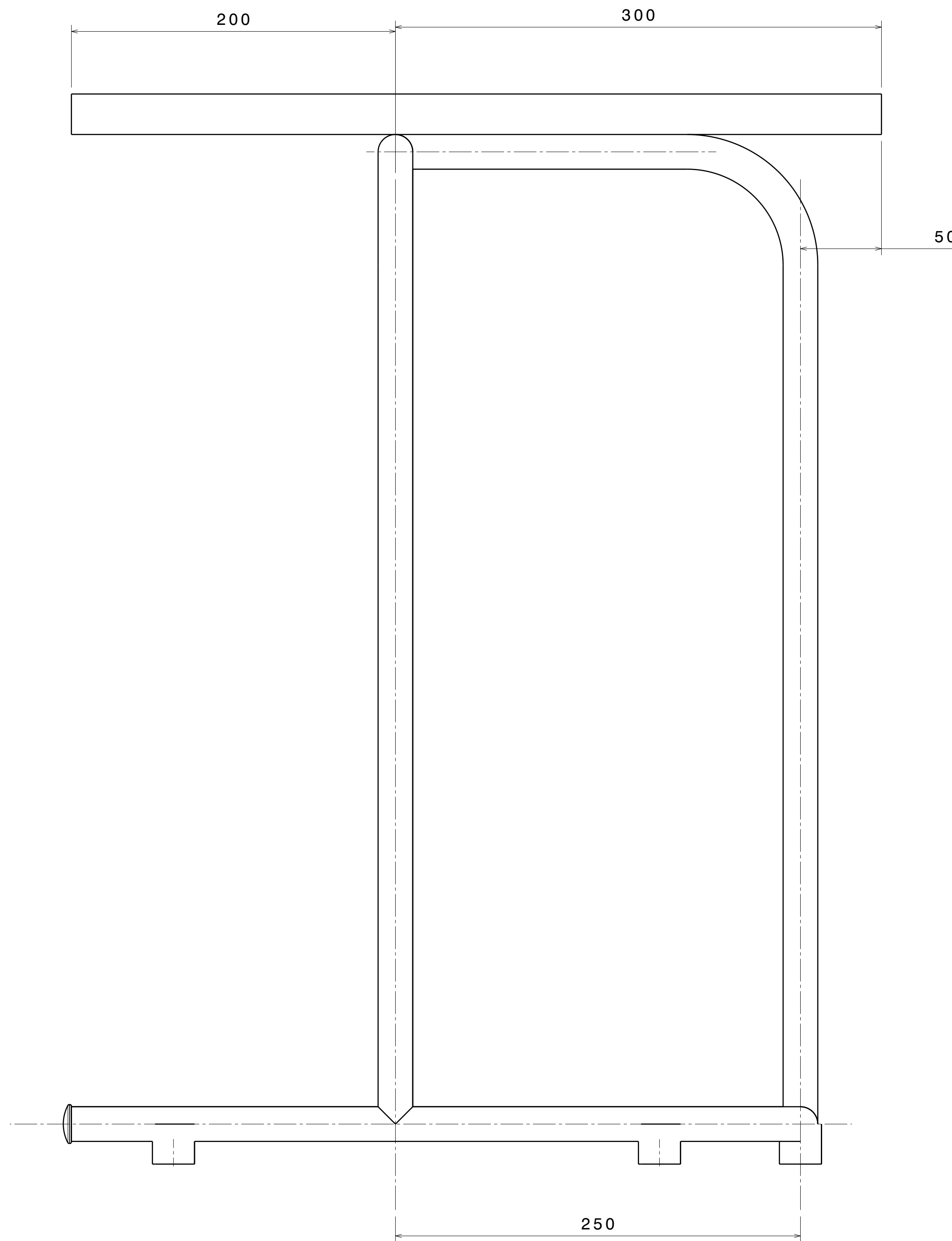

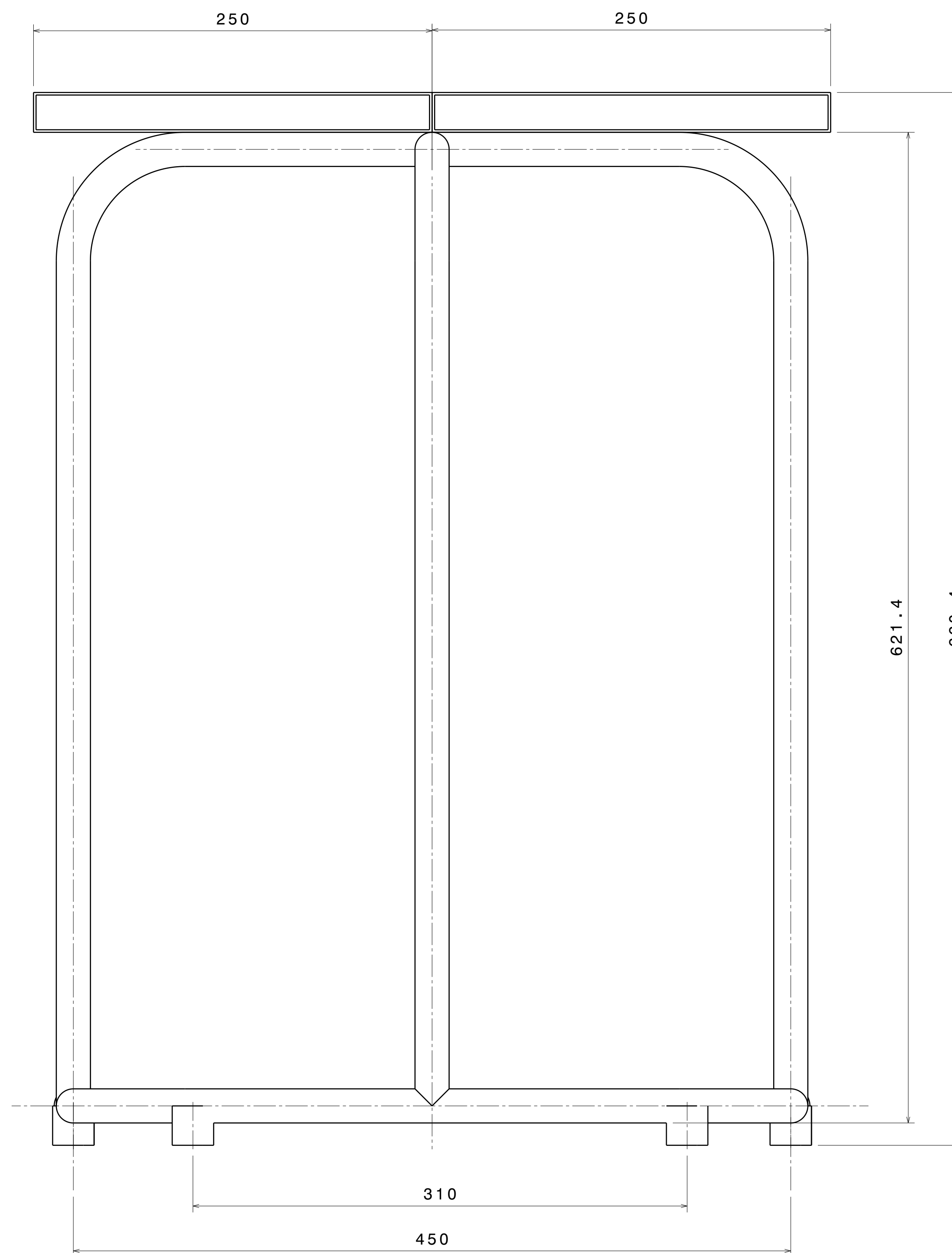

Front view
Scale: 1:2

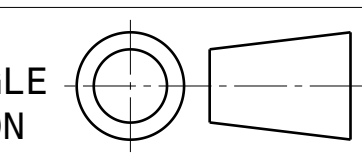

Right view
Scale: 1:2

UNLESS OTHERWISE SPECIFIED DIMENSION ARE IN MM
VIEWS: THIRD ANGLE PROJECTION



This drawing is our property. It can't be reproduced or communicated without our written agreement.		APL APOLLO TUBES LTD. 	
DRAWN BY SB		DATE 28JUL2020	
CHECKED BY P2P Analysis & Solutions		DATE 28JUL2020	
DESIGNED BY P2P Analysis & Solutions		DATE 28JUL2020	
SIZE A0	DRAWING NUMBER P2P MINI STUDY TABLE	REV 00	
SCALE NONE	WEIGHT (kg) XXX	SHEET 2 OF 3	

DRAWING TITLE
MINI STUDY TABLE

REV	DATE	DESCRIPTION
00	28JUL2020	INITIAL REVISION

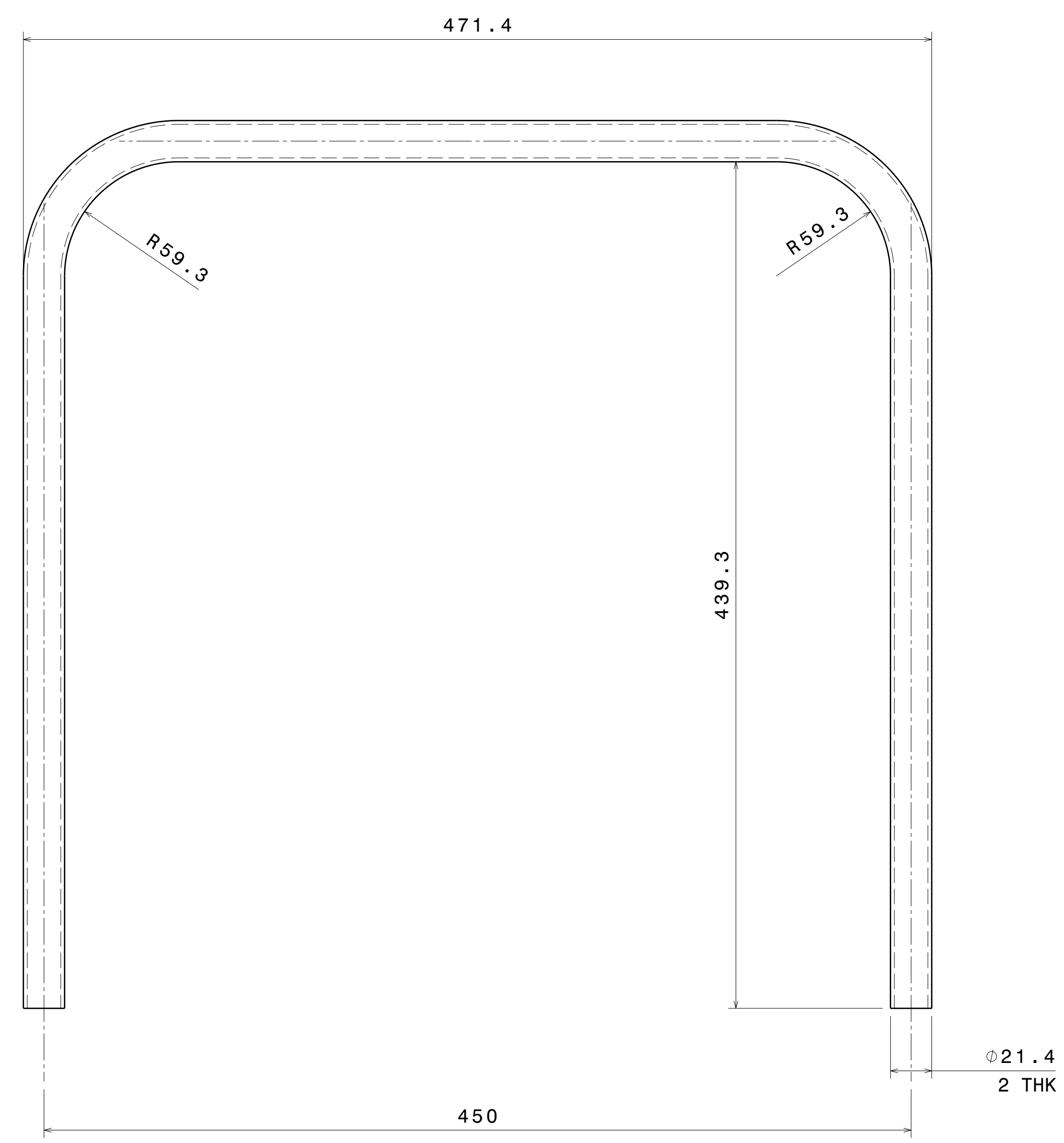

ITEM 1

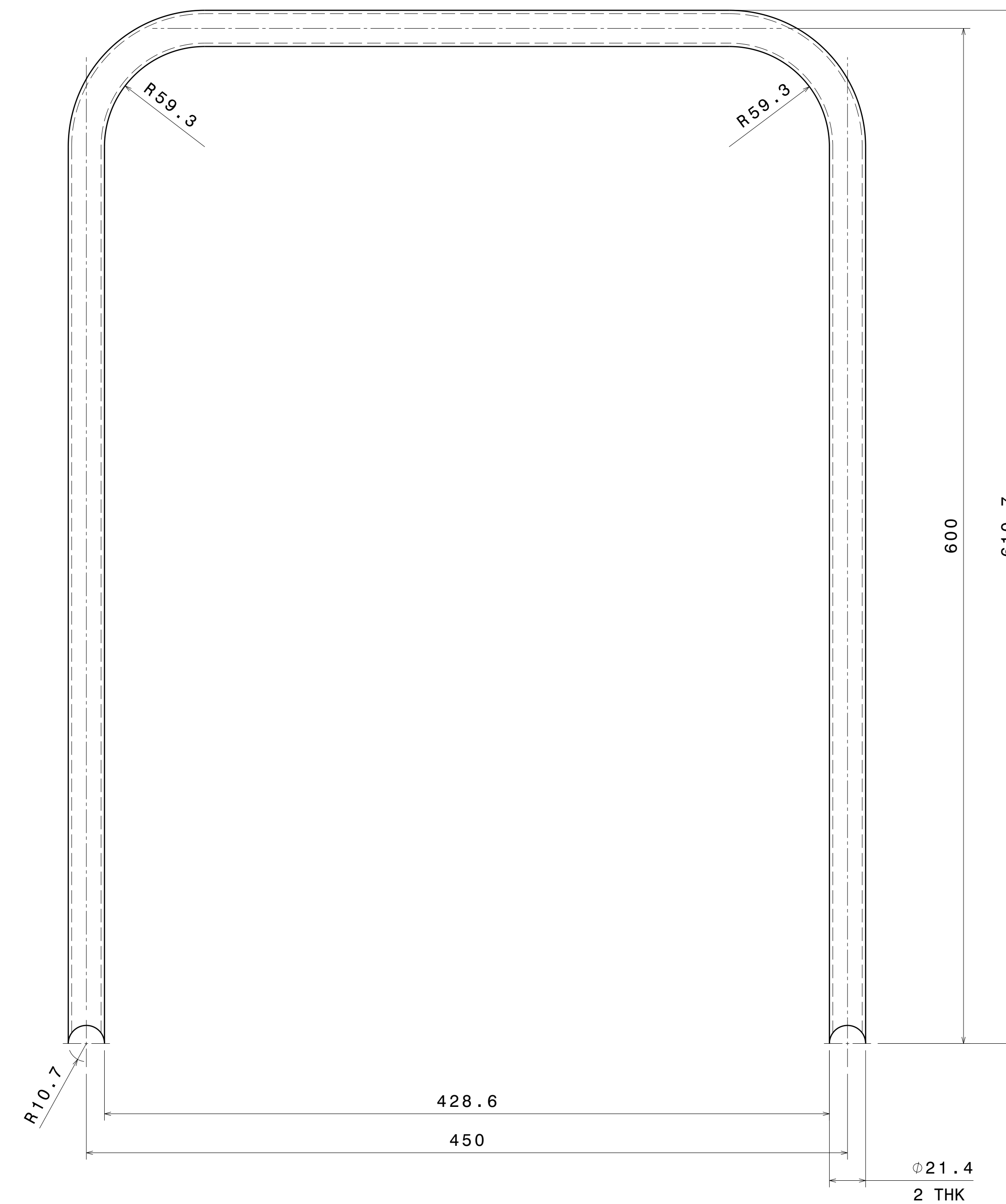

ITEM 2

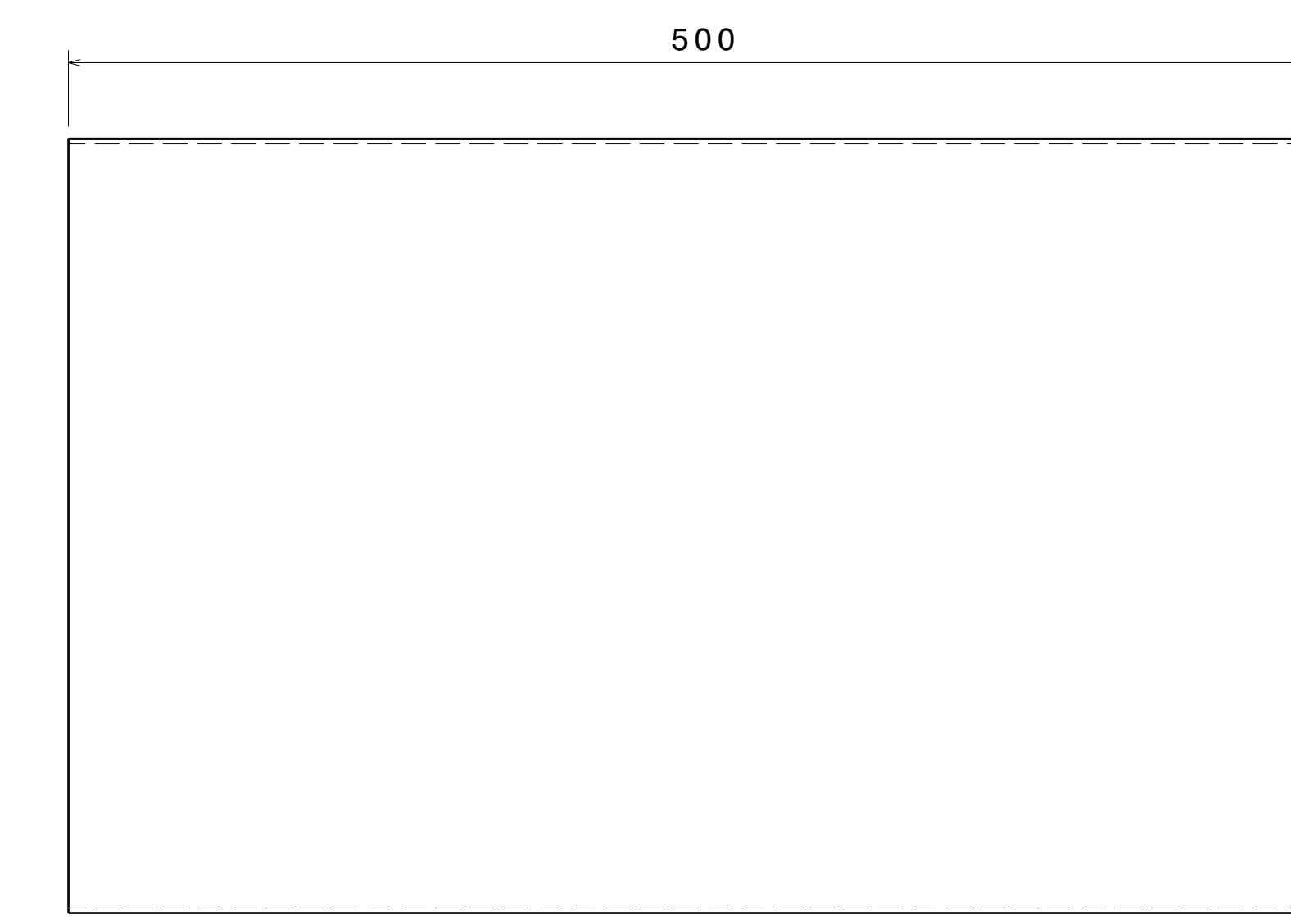

ITEM 4
FRONT VIEW

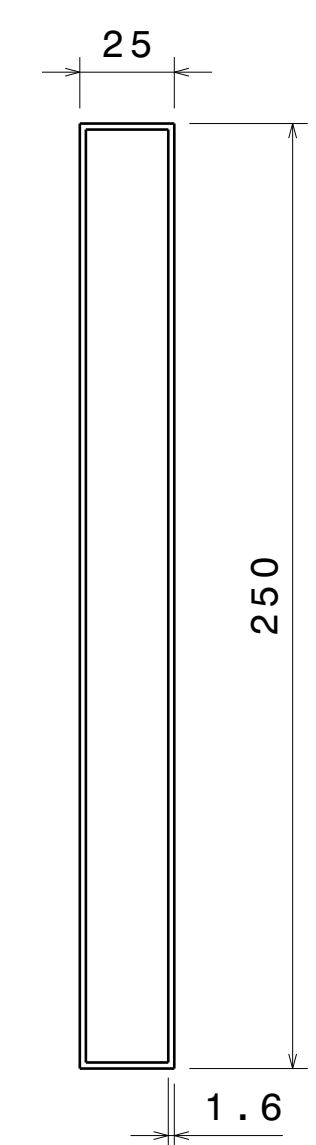



Right view
Scale: 1:2

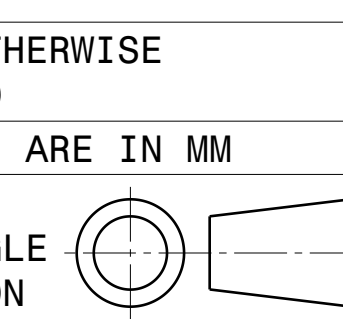

ITEM 3

UNLESS OTHERWISE SPECIFIED DIMENSION ARE IN MM
VIEWS: THIRD ANGLE PROJECTION



This drawing is our property. It can't be reproduced or communicated without our written agreement.		APL APOLLO TUBES LTD. 	
DRAWN BY SB		DATE 28JUL2020	
CHECKED BY P2P Analysis & Solutions		DATE 28JUL2020	
DESIGNED BY P2P Analysis & Solutions		DATE 28JUL2020	
SIZE A0	DRAWING NUMBER P2P MINI STUDY TABLE	REV 00	
SCALE NONE	WEIGHT (kg) XXX	SHEET 3 OF 3	