

REV/DATE	DESCRIPTION
00 / 23/04/2020	INITIAL REVISION

NOTES:

1. (⊥) ALL VERTICAL SUPPORTS ARE PERPENDICULAR.
2. □ FLATNESS OF .5MM IS APPLIED BY DEFAULT.
3. ∇ WELD BEAD OF 2MM RADIUS IS FOLLOWED.
4. ∇∇ SURFACE FINISH MEDIUM TO SMOOTH IS USED.
5. ALL TUBES ARE AS PER APL APOLLO STANDARD. CHANGES MAY EFFECT THE LOAD CAPACITY.
6. ALL HORIZONTAL AND VERTICAL TUBES ARE PERPENDICULAR TO EACH OTHER WITH ±1 DEG.
7. FINE WELDING IS REQUIRED AS PER MENTIONED DETAILS AND FINISHING.
8. HIGHER CURRENT WELDING MAY AFFECT THE BRITTLENESS OF MATERIAL WHICH LATER MAY RAISE TO WEAKENING OF STRUCTURE.
9. FABRICATORS ARE ALLOWED TO USE FITTINGS/FRAMES/SUPPORTS AS NEEDED AND THE SAME MUST BE COMMUNICATED BACK TO ENGINEERING TEAM.
10. LENGTH OF ALL LONGITUDINAL FRAMES ARE FOR REFERENCE ONLY AND SUBJECTED TO CHANGE PER REQUIREMENT.

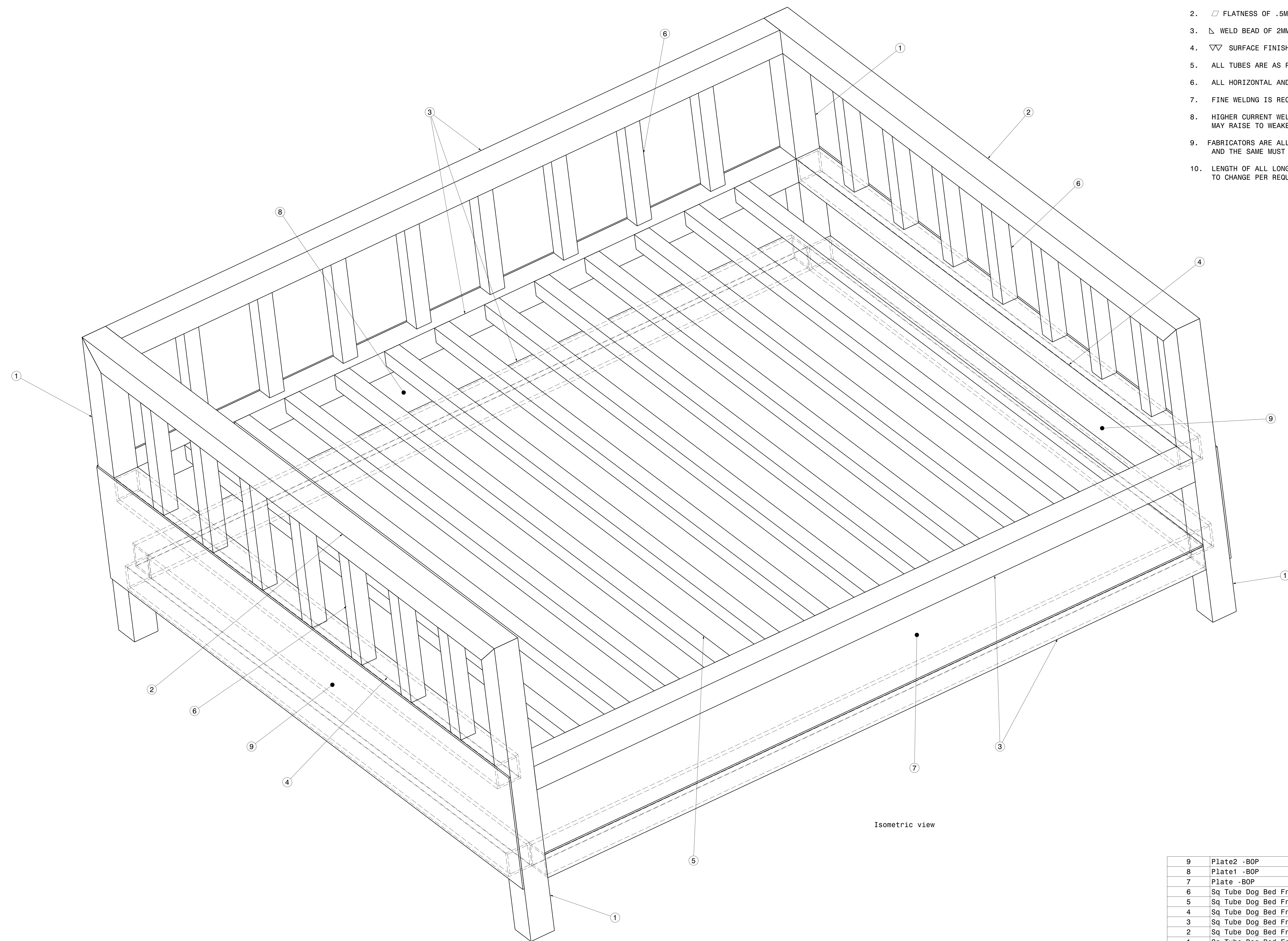

Isometric view

ITEM NO.	PART NUMBER	DESCRIPTION	QTY.	Wt (Kg)/Each
9	Plate2 -BOP	1040 X 190, T=2.5	2	3.9
8	Plate1 -BOP	1200 X 190, T=2.5	1	4.8
7	Plate -BOP	1120 X 1040, T=2.5	1	22.8
6	Sq Tube Dog Bed Frame 6	25 X 25 X 2.6 X 180	22	0.3
5	Sq Tube Dog Bed Frame 5	25 X 25 X 2.6 X 960	12	1.8
4	Sq Tube Dog Bed Frame 4	40 X 40 X 3.2 X 960	4	3.5
3	Sq Tube Dog Bed Frame 3	40 X 40 X 3.2 X 1120	5	4.1
2	Sq Tube Dog Bed Frame 2	40 X 40 X 3.2 X 1040	2	3.7
1	Sq Tube Dog Bed Frame 1	40 X 40 X 3.2 X 500	4	1.8

This drawing is our property. It can't be reproduced or communicated without our written agreement.

APL APOLLO TUBES LTD.

DRAWING TITLE: **DOG BED**

DRAWN BY: SB	DATE: 23/04/2020	SIZE: A0	DRAWING NUMBER: P2P DOG BED	REV: 00
CHECKED BY: P2P Analysis & Solutions	DATE: 23/04/2020	SCALE: As Indicated	WEIGHT (kg): 0kg	SHEET 1 OF 5
DESIGNED BY: P2P Analysis & Solutions	DATE: 23/04/2020			

UNLESS OTHERWISE SPECIFIED DIMENSION ARE IN MM
 VIEWS: THIRD ANGLE PROJECTION

REV	DATE	DESCRIPTION
00	23/04/2020	INITIAL REVISION

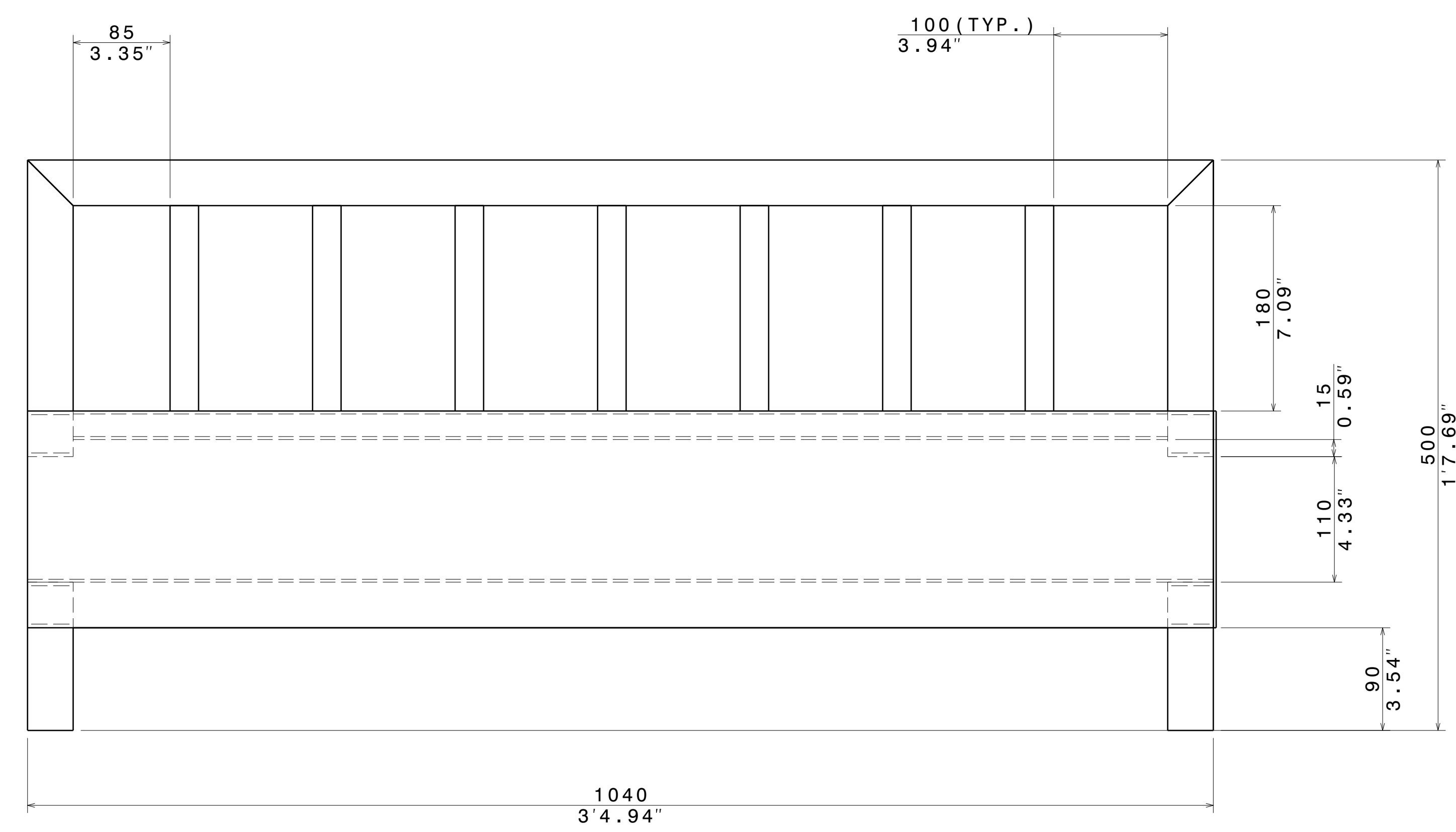
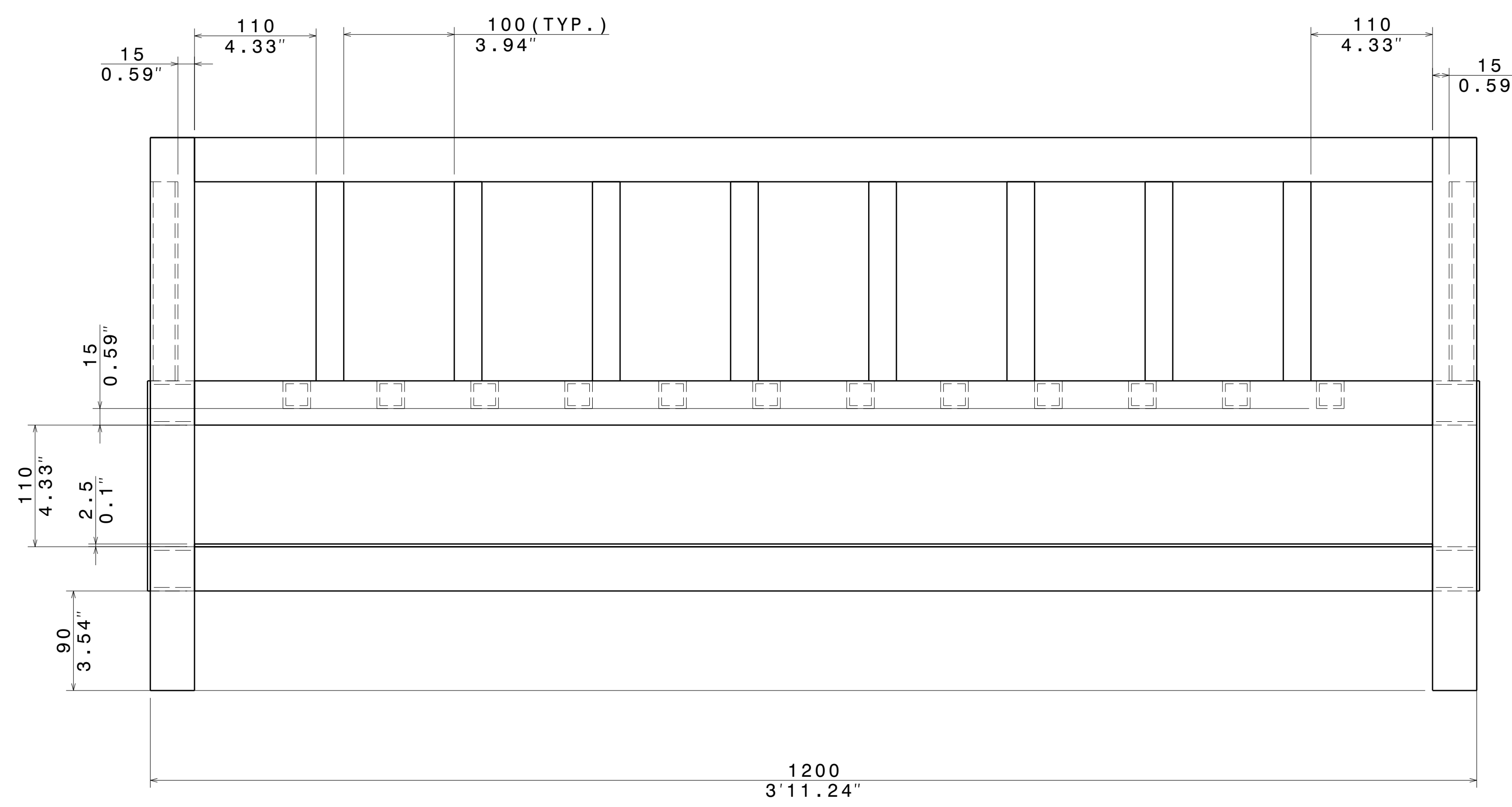
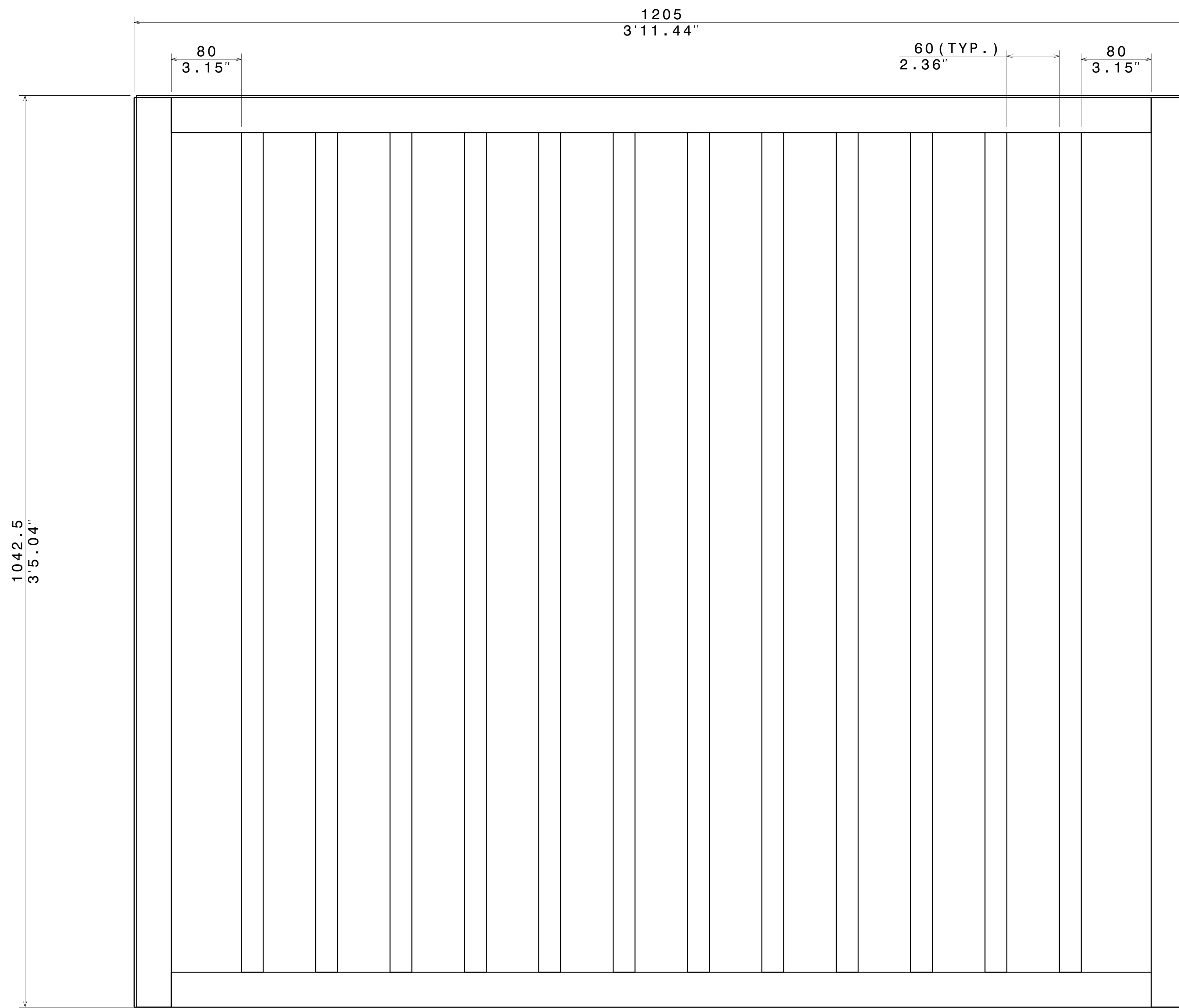

UNLESS OTHERWISE SPECIFIED DIMENSION ARE IN MM
 VIEWS: THIRD ANGLE PROJECTION

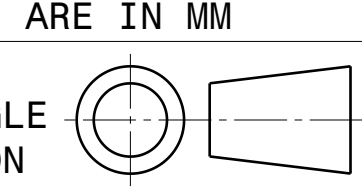

This drawing is our property. It can't be reproduced or communicated without our written agreement.

DRAWN BY	DATE
SB	23/04/2020
CHECKED BY	DATE
P2P Analysis & Solutions	23/04/2020
DESIGNED BY	DATE
P2P Analysis & Solutions	23/04/2020

APL APOLLO TUBES LTD. 	
DRAWING TITLE	
DOG BED	
SIZE	DRAWING NUMBER
A0	P2P DOG BED
SCALE	WEIGHT (kg)
NONE	XXX
REV	SHEET 2 OF 5
00	

REV	DATE	DESCRIPTION
00	23/04/2020	INITIAL REVISION

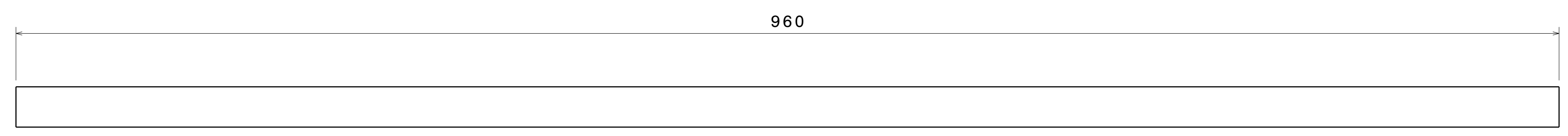

ITEM 5 DETAILS
Sq Tube Dog Bed Frame 5

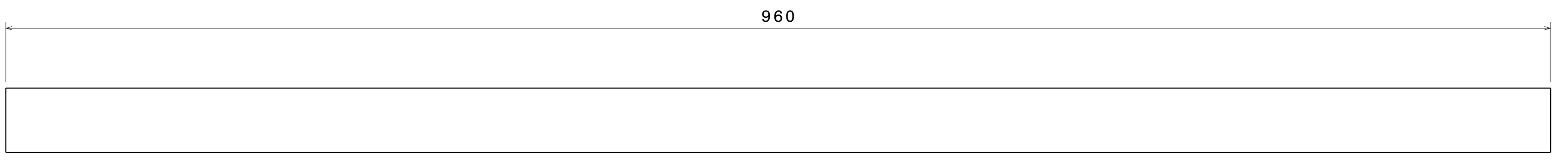

ITEM 4 DETAILS
Sq Tube Dog Bed Frame 4

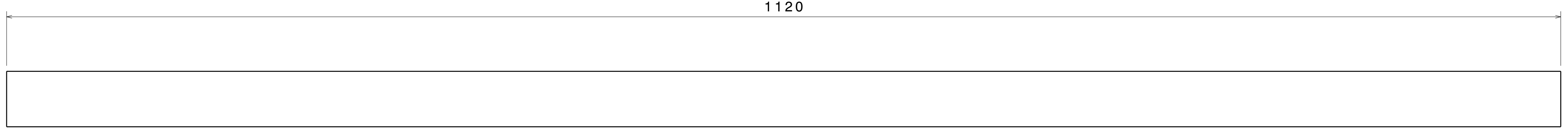

ITEM 3 DETAILS
Sq Tube Dog Bed Frame 3

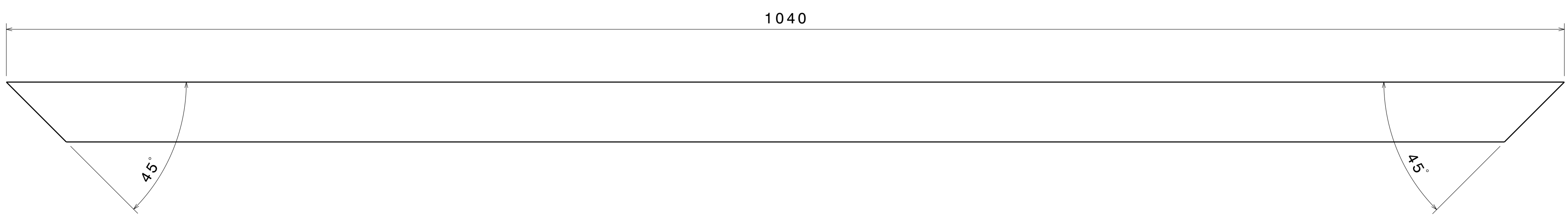

ITEM 2 DETAILS
Sq Tube Dog Bed Frame 2



ITEM 1 DETAILS
Sq Tube Dog Bed Frame 1

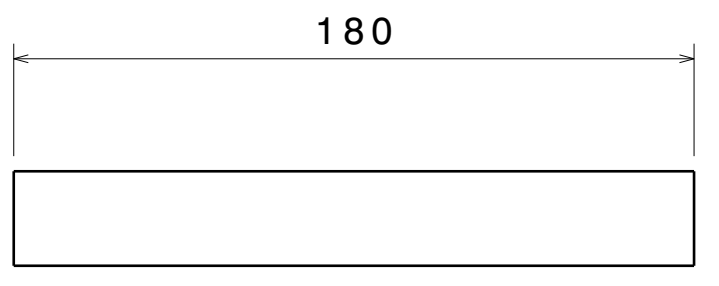

ITEM 6 DETAILS
Sq Tube Dog Bed Frame 6

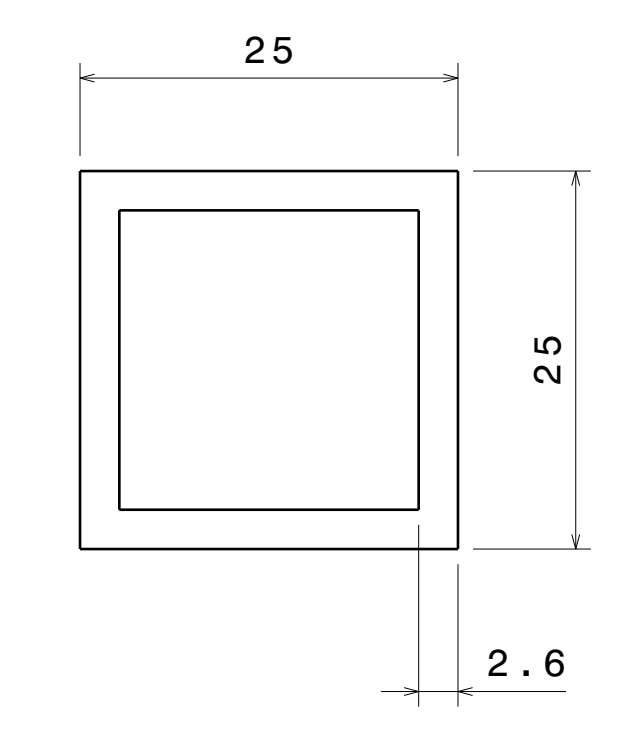

Section Detail of ITEM 5 & 6
Scale: 2:1

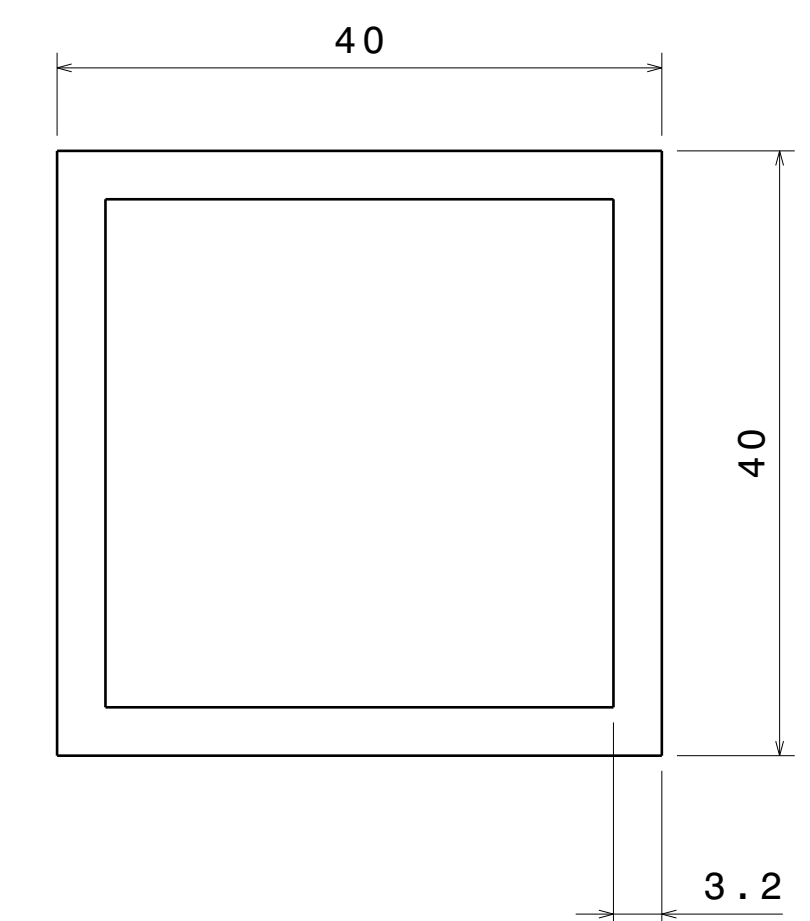

Section Detail of ITEM 1,2,3 & 4
Scale: 2:1

UNLESS OTHERWISE SPECIFIED DIMENSION ARE IN MM
VIEWS: THIRD ANGLE PROJECTION

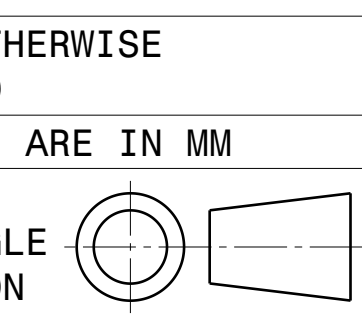

This drawing is our property. It can't be reproduced or communicated without our written agreement.

DRAWN BY	DATE
SB	23/04/2020
CHECKED BY	DATE
P2P Analysis & Solutions	23/04/2020
DESIGNED BY	DATE
P2P Analysis & Solutions	23/04/2020

APL APOLLO TUBES LTD. 	
DRAWING TITLE	
DOG BED	
SIZE	DRAWING NUMBER
A0	P2P DOG BED
SCALE	WEIGHT (kg)
NONE	XXX
REV	SHEET 3 OF 5
00	