

REV	DATE	DESCRIPTION
00	18/04/2020	INITIAL REVISION

NOTES:

1. (⊥) ALL VERTICAL SUPPORTS ARE PERPENDICULAR.
2. □ FLATNESS OF .5MM IS APPLIED BY DEFAULT.
3. ∇ WELD BEAD OF 2MM RADIUS IS FOLLOWED.
4. ∇∇ SURFACE FINISH MEDIUM TO SMOOTH IS USED.
5. ALL TUBES ARE AS PER APL APOLLO STANDARD. CHANGES MAY EFFECT THE LOAD CAPACITY.
6. ALL HORIZONTAL AND VERTICAL TUBES ARE PERPENDICULAR TO EACH OTHER WITH ±1 DEG.
7. FINE WELDNG IS REQUIRED AS PER MENTIONED DETAILS AND FINISHING.
8. HIGHER CURRENT WELDING MAY AFFECT THE BRITTLENESS OF MATERIAL WHICH LATER MAY RAISE TO WEAKENING OF STRUCTURE.
9. FABRICATORS ARE ALLOWED TO USE FITTINGS/FRAMES/SUPPORTS AS NEEDED AND THE SAME MUST BE COMMUNICATED BACK TO ENGINEERING TEAM.
10. LENGTH OF ALL LONGITUDINAL FRAMES ARE FOR REFERENCE ONLY AND SUBJECTED TO CHANGE PER REQUIREMENT.

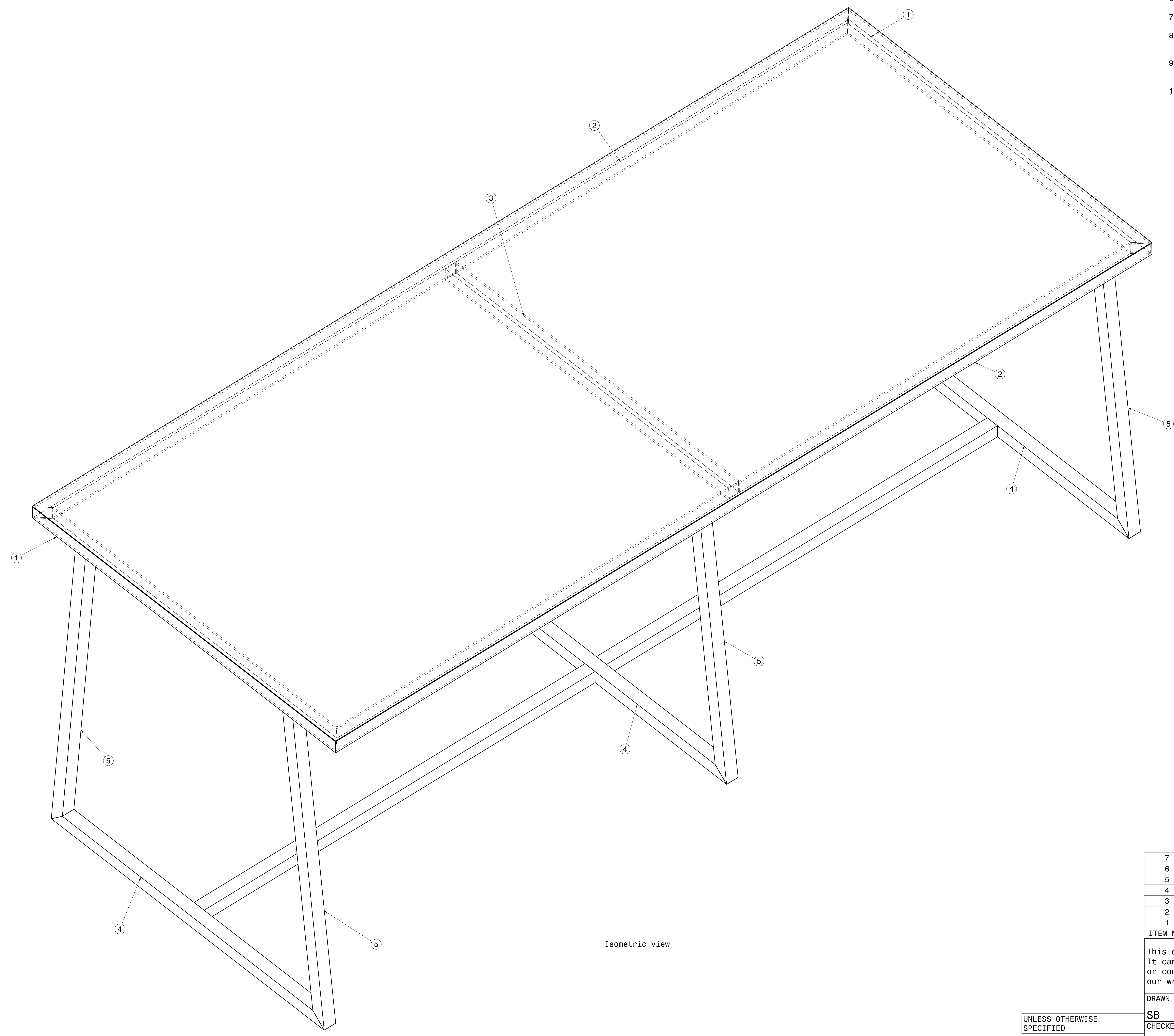

Isometric view

ITEM NO.	PART NUMBER	DESCRIPTION	QTY.	Wt (Kg)/Each
7	Plate -BOP	2840 X 1200, T=2.5	1	67
6	Sq Tube Bench Frame 6	40 X 40 X 2.9 X 1360	2	4.6
5	Sq Tube Bench Frame 5	40 X 40 X 2.9 X 1050	6	4.5
4	Sq Tube Bench Frame 4	40 X 40 X 2.9 X 1080	3	3.5
3	Sq Tube Bench Frame 3	40 X 40 X 2.9 X 1120	1	3.8
2	Sq Tube Bench Frame 2	40 X 40 X 2.9 X 2840	2	9.5
1	Sq Tube Bench Frame 1	40 X 40 X 2.9 X 1200	2	3.9

This drawing is our property. It can't be reproduced or communicated without our written agreement.

**APL APOLLO TUBES LTD.**

DRAWING TITLE: **BENCH**

DRAWN BY: SB	DATE: 18/04/2020	SIZE: A0	DRAWING NUMBER: P2P BENCH	REV: 00
CHECKED BY: P2P Analysis & Solutions	DATE: 18/04/2020	SCALE: As Indicated	WEIGHT (kg): 0kg	SHEET 1 OF 5
DESIGNED BY: P2P Analysis & Solutions	DATE: 18/04/2020			

UNLESS OTHERWISE SPECIFIED DIMENSION ARE IN MM  
 VIEWS: THIRD ANGLE PROJECTION

REV	DATE	DESCRIPTION
00	18/04/2020	INITIAL REVISION

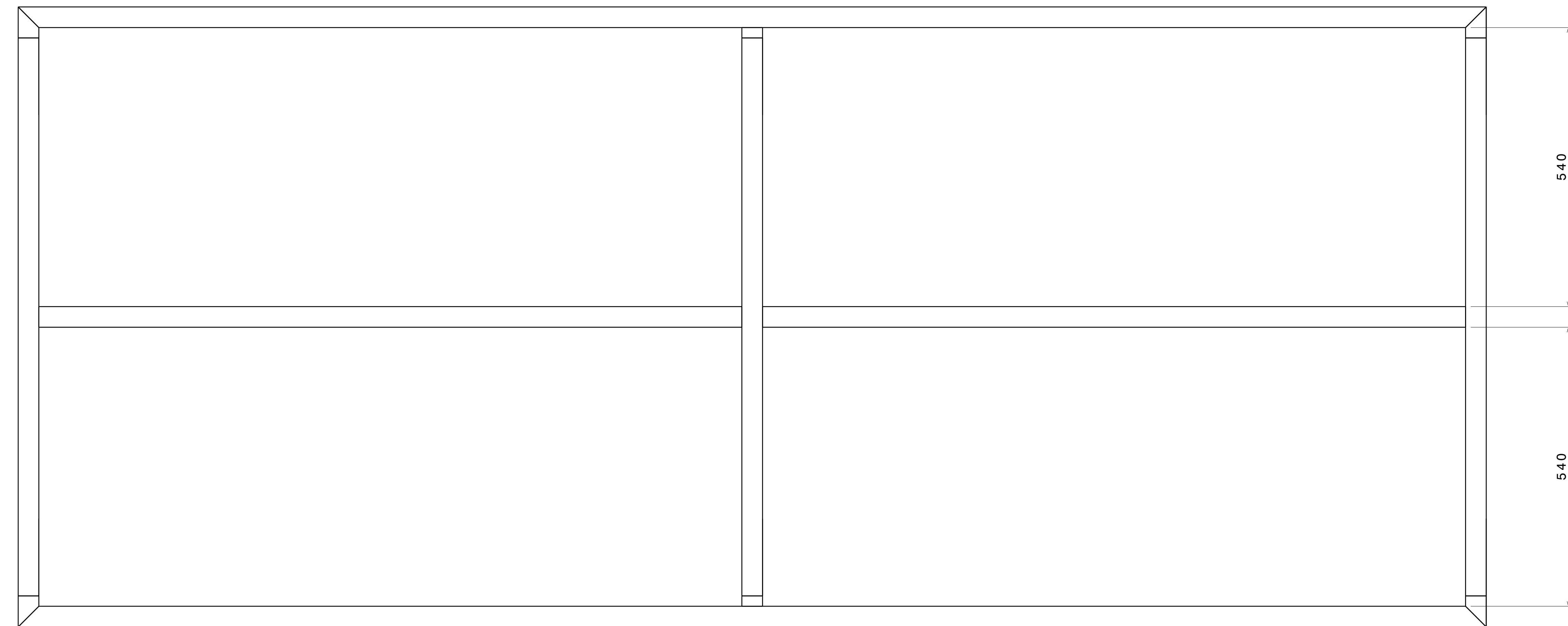
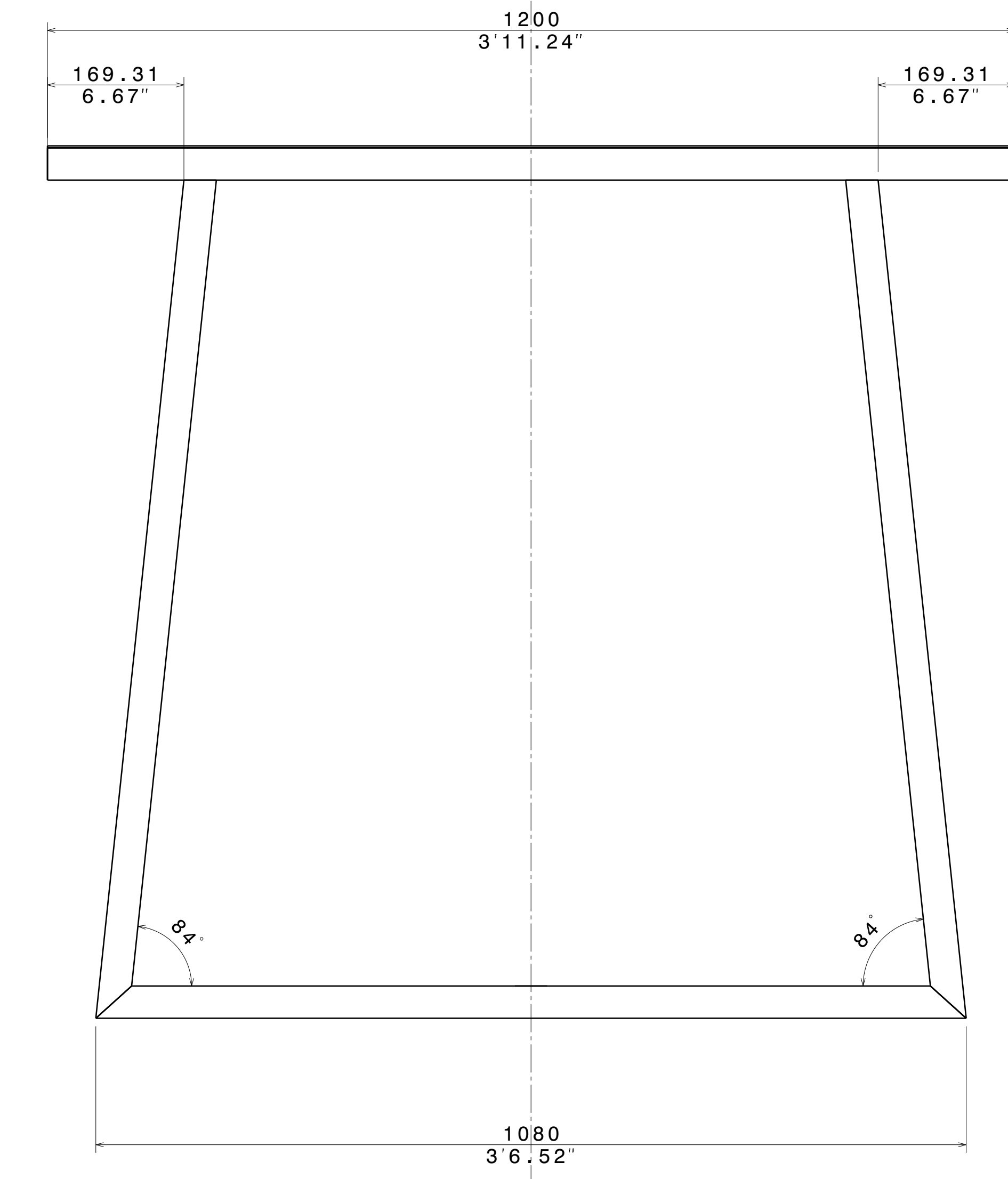
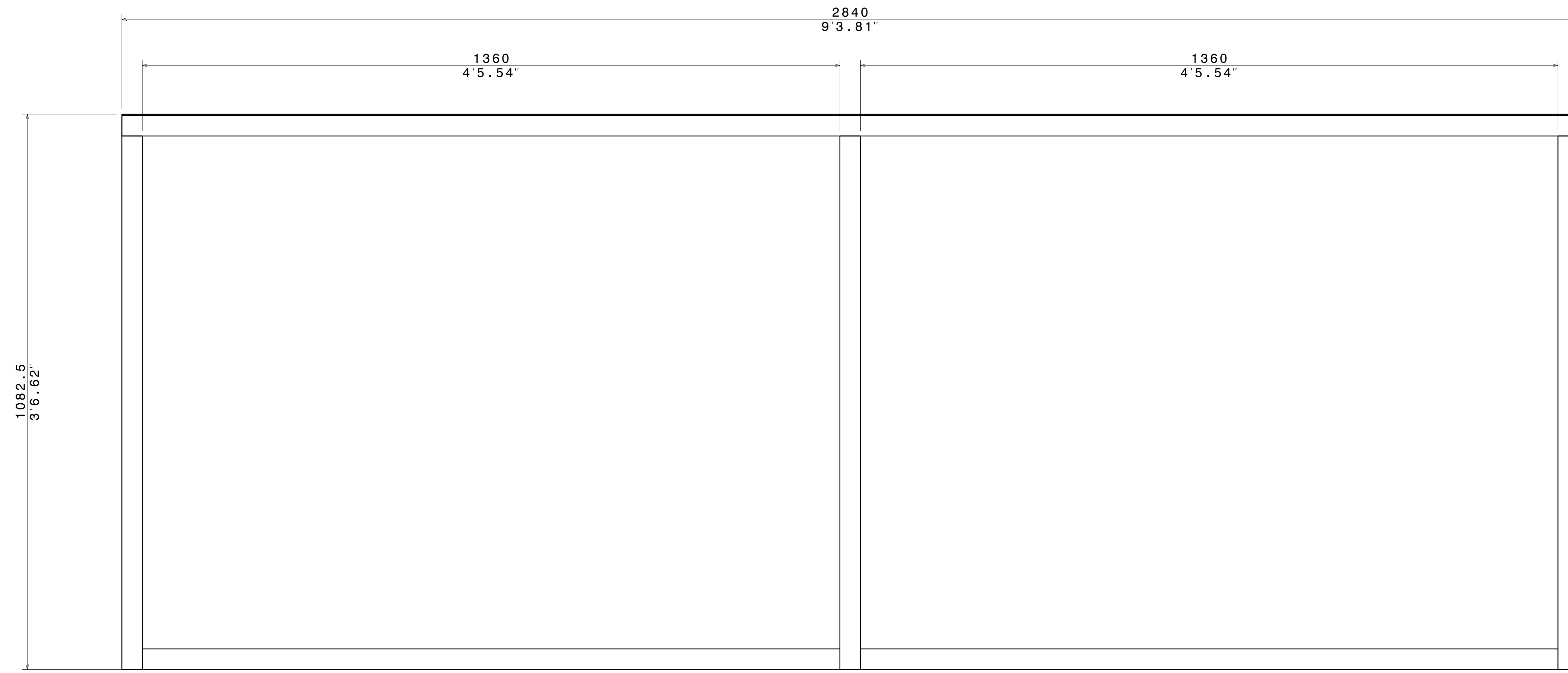

UNLESS OTHERWISE SPECIFIED DIMENSION ARE IN MM  
 VIEWS: THIRD ANGLE PROJECTION

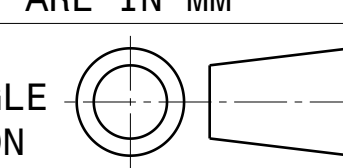

This drawing is our property. It can't be reproduced or communicated without our written agreement.		APL APOLLO TUBES LTD. 	
DRAWN BY SB		DATE 18/04/2020	
CHECKED BY P2P Analysis & Solutions		DATE 18/04/2020	
DESIGNED BY P2P Analysis & Solutions		DATE 18/04/2020	
DRAWING TITLE BENCH		SIZE A0	DRAWING NUMBER P2P BENCH
SCALE NONE		WEIGHT (kg) XXX	REV 00
		SHEET 2 OF 5	



REV	DATE	DESCRIPTION
00	18/04/2020	INITIAL REVISION

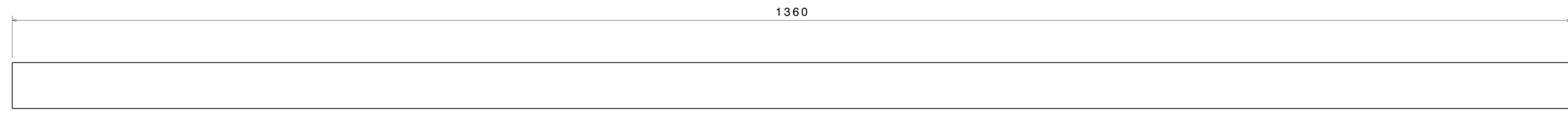

ITEM 6 DETAILS  
Sq Tube Bench Frame 6

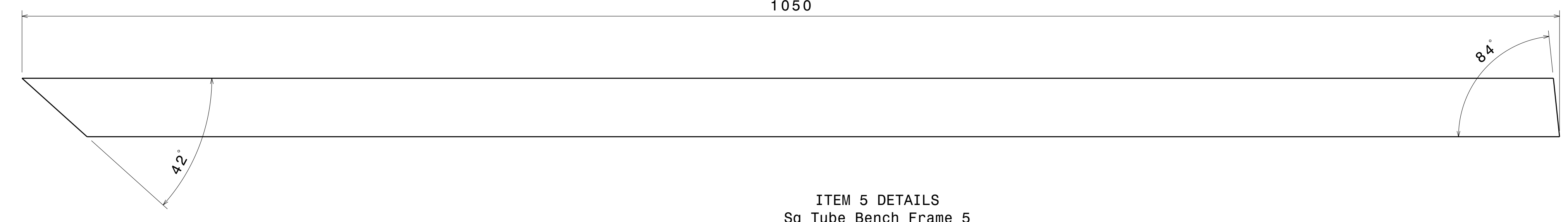

ITEM 5 DETAILS  
Sq Tube Bench Frame 5

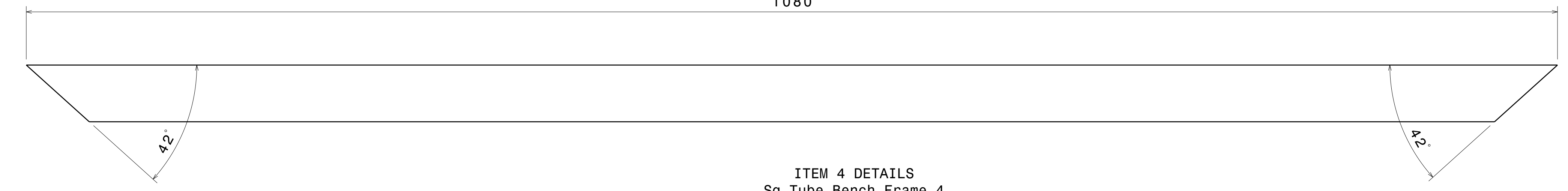

ITEM 4 DETAILS  
Sq Tube Bench Frame 4

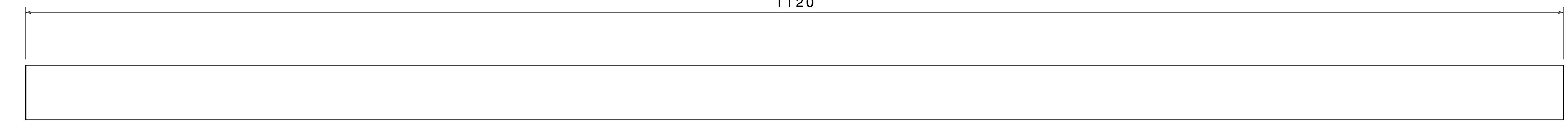

ITEM 3 DETAILS  
Sq Tube Bench Frame 3

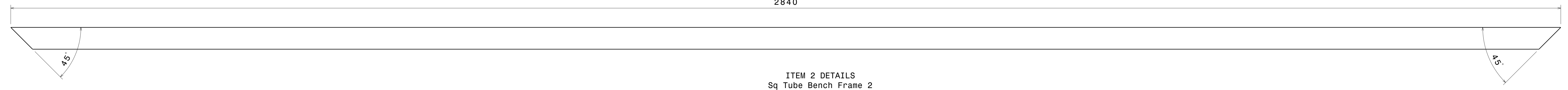

ITEM 2 DETAILS  
Sq Tube Bench Frame 2

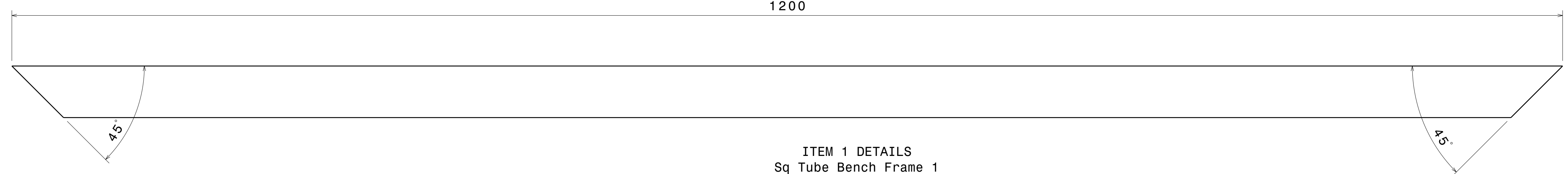

ITEM 1 DETAILS  
Sq Tube Bench Frame 1

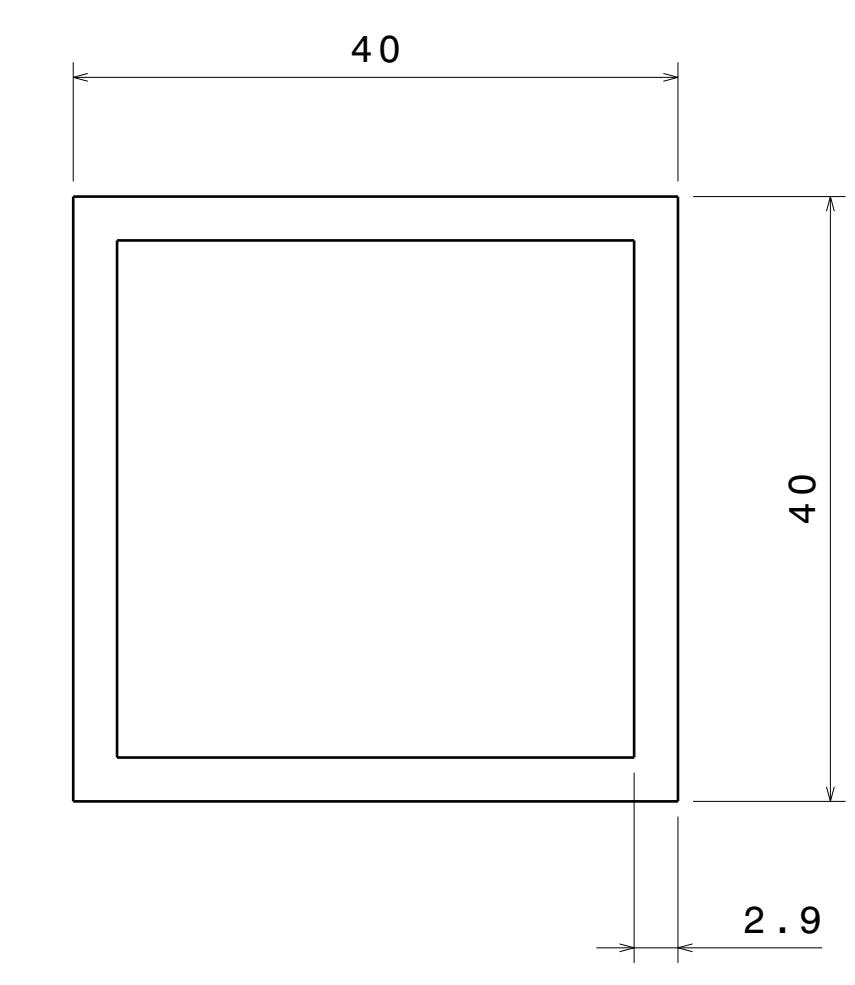

Section Detail of ITEM 1,2,3,4,5 & 6  
Scale: 2:1

UNLESS OTHERWISE SPECIFIED DIMENSION ARE IN MM  
VIEWS: THIRD ANGLE PROJECTION

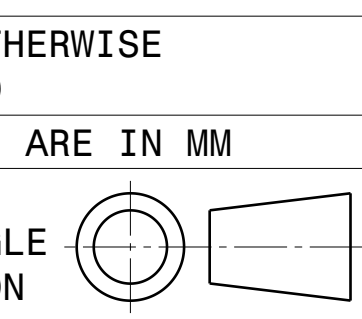

This drawing is our property. It can't be reproduced or communicated without our written agreement.

DRAWN BY	DATE
SB	18/04/2020
CHECKED BY	DATE
P2P Analysis & Solutions	18/04/2020
DESIGNED BY	DATE
P2P Analysis & Solutions	18/04/2020

APL APOLLO TUBES LTD.

DRAWING TITLE		BENCH		REV
SIZE	DRAWING NUMBER			00
A0	P2P BENCH			
SCALE	NONE	WEIGHT (kg)	XXX	SHEET 3 OF 5