

REV/DATE	DESCRIPTION
00 16JUN2020	INITIAL REVISION

- NOTES:
- (⊥) ALL VERTICAL SUPPORTS ARE PERPENDICULAR.
 - FLATNESS OF .5MM IS APPLIED BY DEFAULT.
 - ⊲ WELD BEAD OF 2MM RADIUS IS FOLLOWED.
 - ▽ SURFACE FINISH MEDIUM TO SMOOTH IS USED.
 - ALL TUBES ARE AS PER APL APOLLO STANDARD. CHANGES MAY EFFECT THE LOAD CAPACITY.
 - ALL HORIZONTAL AND VERTICAL TUBES ARE PERPENDICULAR TO EACH OTHER WITH ±1 DEG.
 - FINE WELDING IS REQUIRED AS PER MENTIONED DETAILS AND FINISHING.
 - HIGHER CURRENT WELDING MAY AFFECT THE BRITTLENESS OF MATERIAL WHICH LATER MAY RAISE TO WEAKENING OF STRUCTURE.
 - FABRICATORS ARE ALLOWED TO USE FITTINGS/FRAMES/SUPPORTS AS NEEDED AND THE SAME MUST BE COMMUNICATED BACK TO ENGINEERING TEAM.
 - BOP COMPONENT WEIGHTS ARE FOR REFERENCE ONLY AND SUBJECTED TO CHANGE PER PURCHASED COMPONENTS.

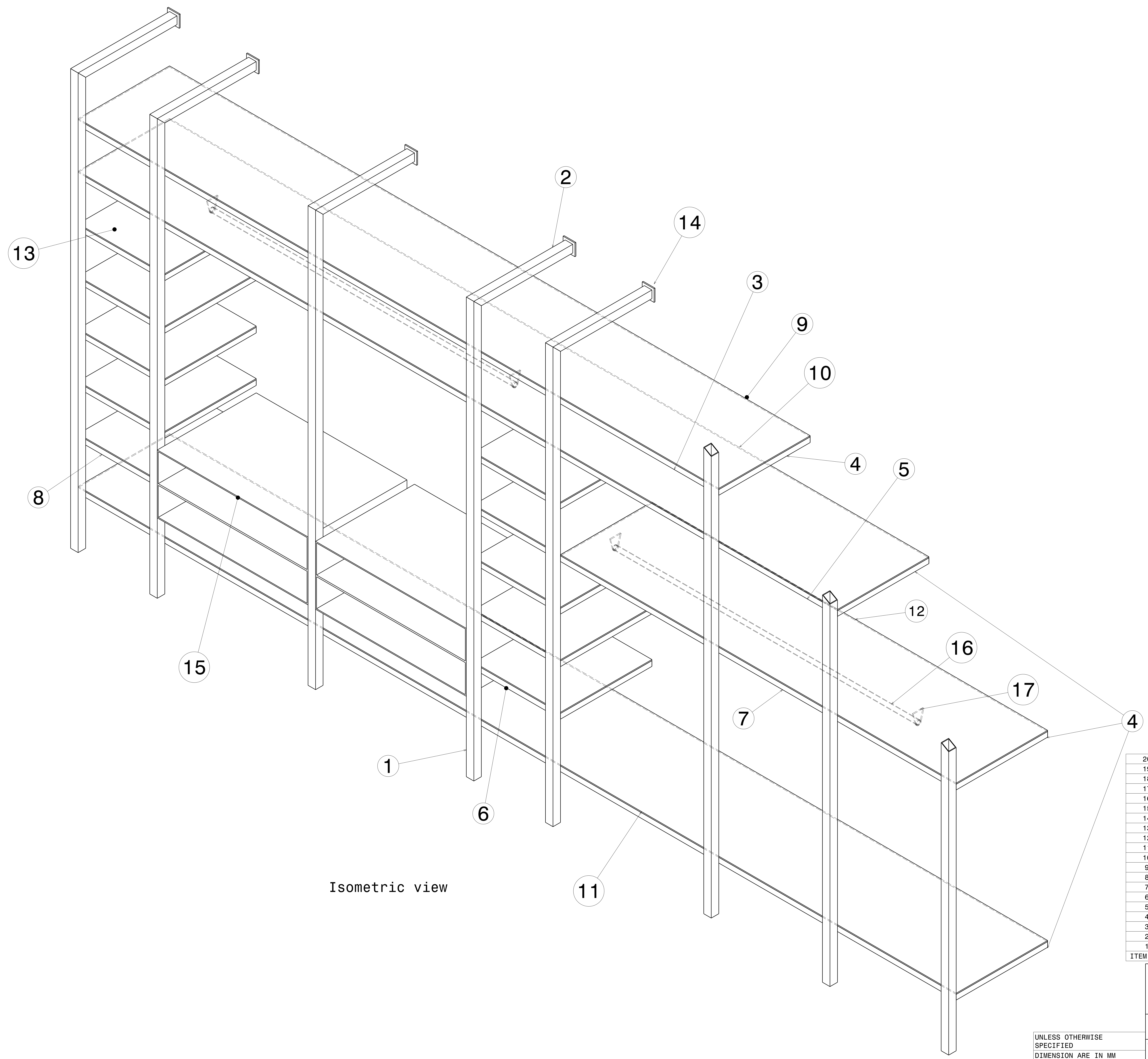

Isometric view

ITEM NO.	PART NUMBER	DESCRIPTION	QTY.	Wt(Kg)/Each
20	May 20 Frame 12	38SQ X 2 X 1350	1	2.9
19	May 20 Frame 11	38SQ X 2 X 1696	1	3.8
18	May 20 Frame 10	38SQ X 2 X 2043	1	4.65
17	May 20 BOP 8	--	4	0.07
16	May 20 Frame 9	DIA 21 X 2 X 1535	2	1.44
15	May 20 BOP 7	--	2	70
14	May 20 BOP 6	60 X 60 X 5	5	0.14
13	May 20 BOP 5	438 X 462 X 5	10	8
12	May 20 BOP 4	2000 X 462 X 5	1	36.3
11	May 20 BOP 3	4438 X 462 X 5	5	80.6
10	May 20 BOP 2	3838 X 462 X 5	1	70
9	May 20 BOP 1	3238 X 462 X 5	1	58.8
8	May 20 Frame 8	25SQ X 1.6 X 438	20	0.48
7	May 20 Frame 7	25SQ X 1.6 X 2000	2	2.35
6	May 20 Frame 6	25SQ X 1.6 X 4438	2	5.2
5	May 20 Frame 5	25SQ X 1.6 X 3838	2	4.5
4	May 20 Frame 4	25SQ X 1.6 X 462	27	0.52
3	May 20 Frame 3	25SQ X 1.6 X 3238	2	3.8
2	May 20 Frame 2	38SQ X 2 X 500	5	0.93
1	May 20 Frame 1	38SQ X 2 X 2100	5	4.72

This drawing is our property. It can't be reproduced or communicated without our written agreement.

APL APOLLO TUBES LTD.

DRAWING TITLE: May 19

SCALE: As Indicated

WEIGHT(kg): 0kg

SHEET 1 OF 3

DRAWN BY: SB	DATE: 16JUN2020	CHECKED BY: P2P Analysis & Solutions	DATE: 16JUN2020	DESIGNED BY: P2P Analysis & Solutions	DATE: 16JUN2020
--------------	-----------------	--------------------------------------	-----------------	---------------------------------------	-----------------

UNLESS OTHERWISE SPECIFIED DIMENSION ARE IN MM
 VIEWS: THIRD ANGLE PROJECTION

REV	DATE	DESCRIPTION
00	16JUN2020	INITIAL REVISION

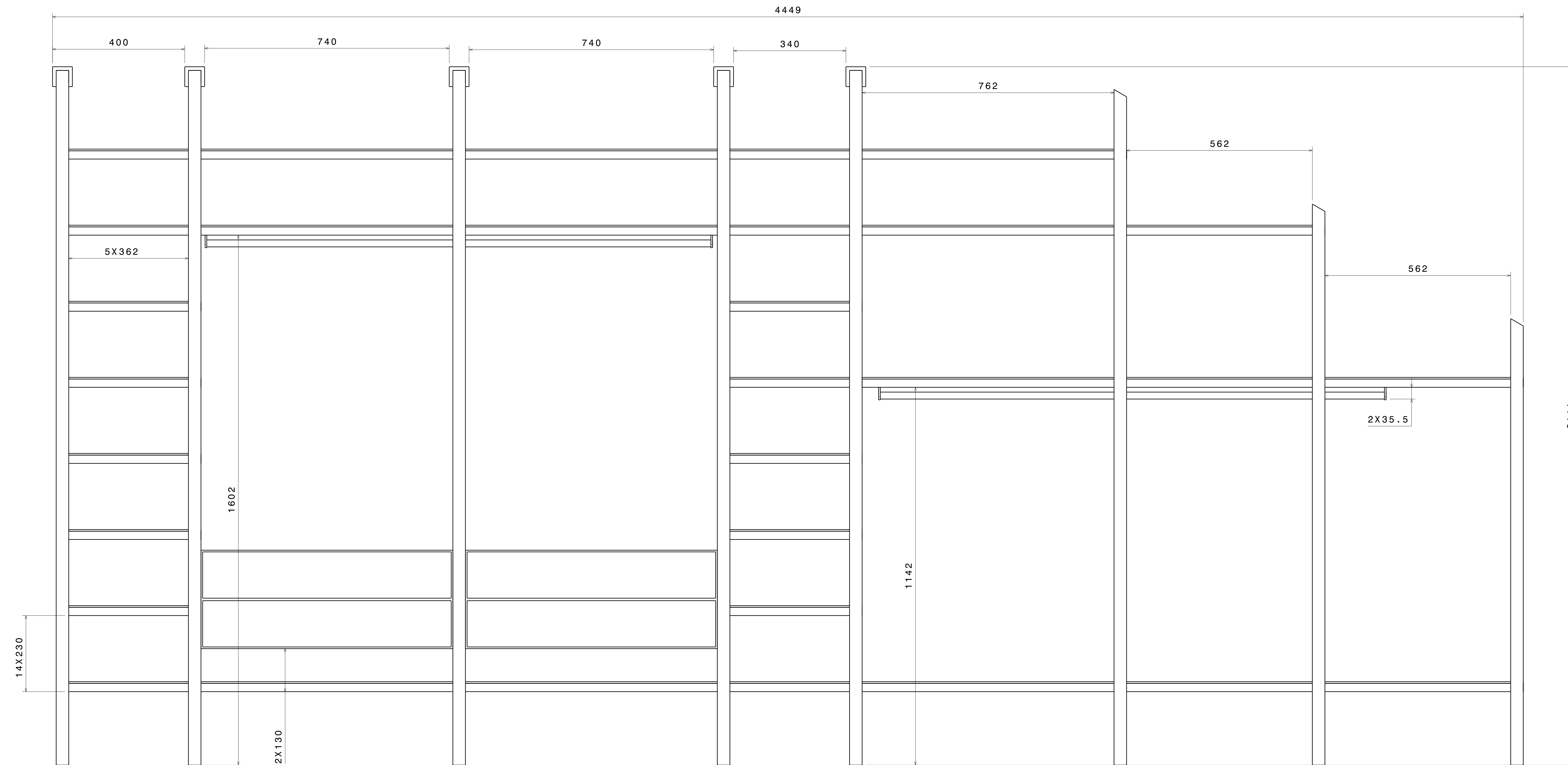

Front view

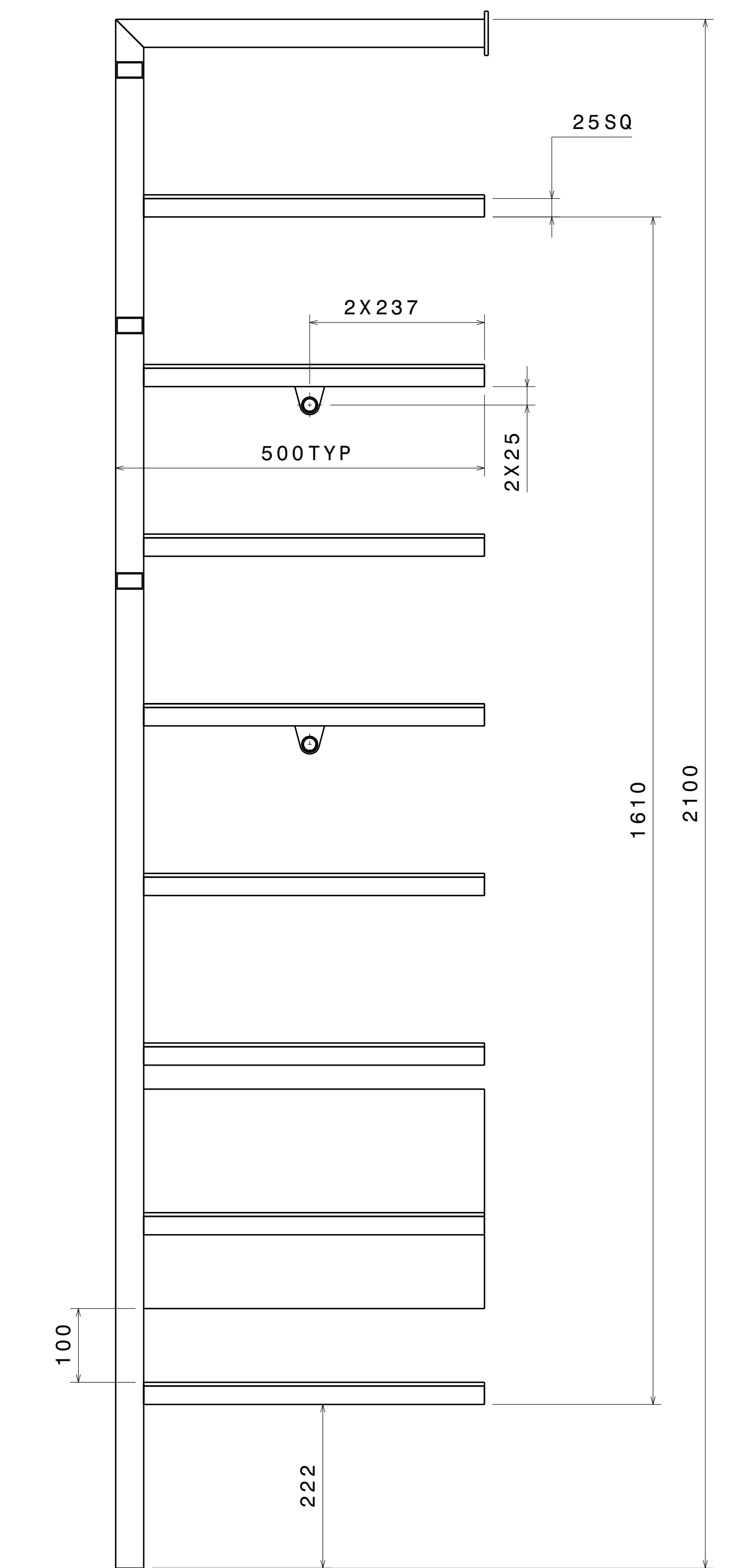

Right view

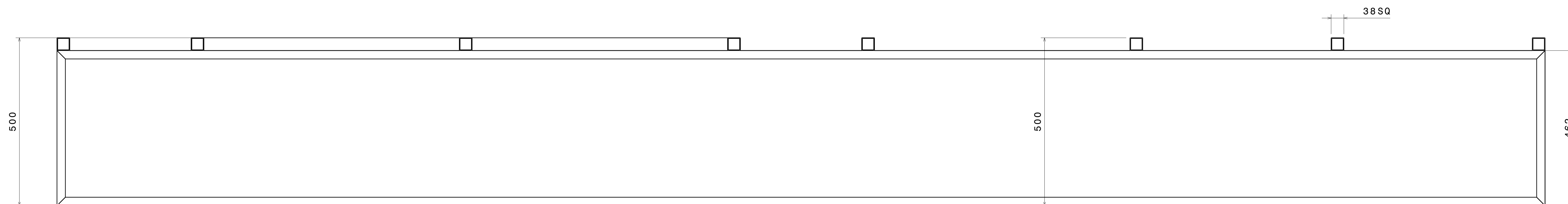

Bottom view

UNLESS OTHERWISE SPECIFIED DIMENSION ARE IN MM VIEWS: THIRD ANGLE PROJECTION

This drawing is our property. It can't be reproduced or communicated without our written agreement.		APL APOLLO TUBES LTD.	
DRAWN BY SB		DATE 16JUN2020	
CHECKED BY P2P Analysis & Solutions		DATE 16JUN2020	
DESIGNED BY P2P Analysis & Solutions		DATE 16JUN2020	
SIZE A0	DRAWING NUMBER P2P May 19	REV 00	
SCALE NONE	WEIGHT (kg) XXX	SHEET 2 OF 3	

REV	DATE	DESCRIPTION
00	16JUN2020	INITIAL REVISION

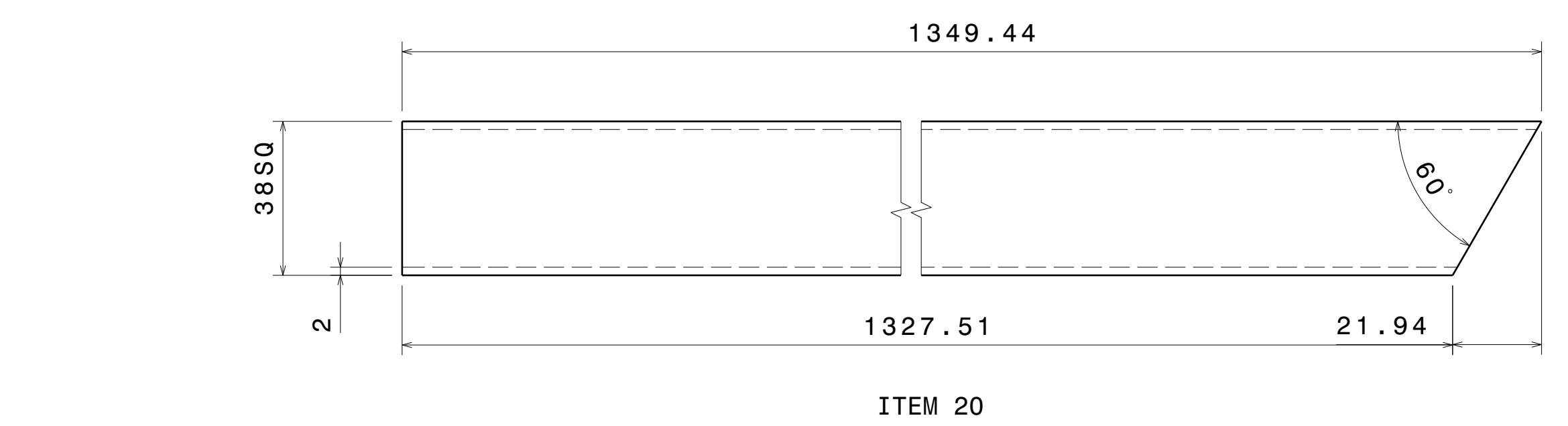
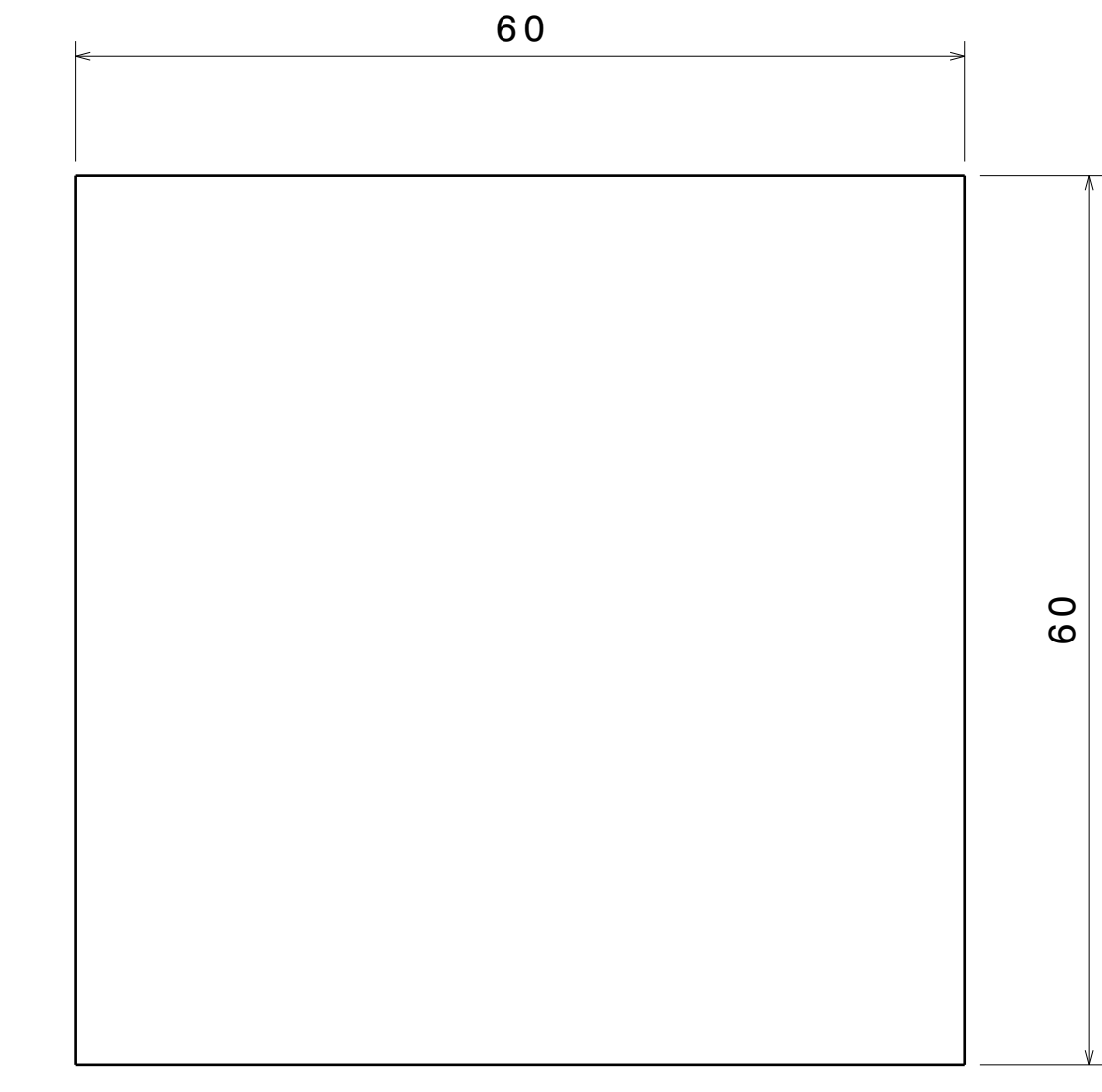
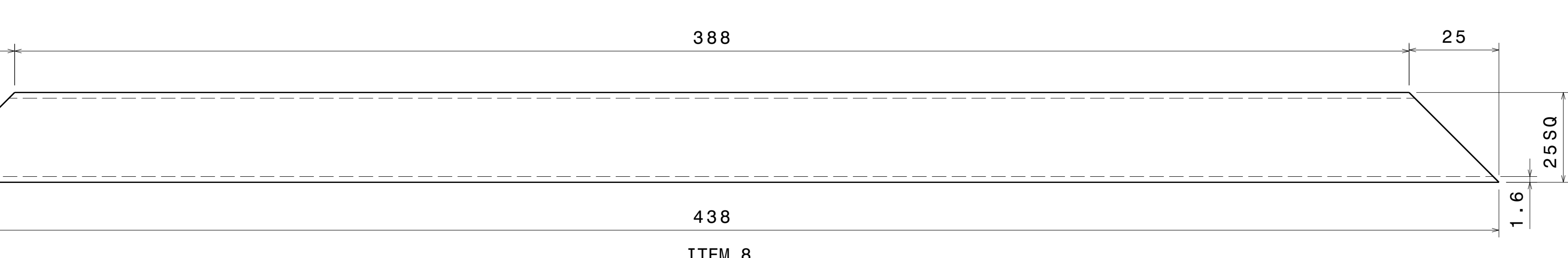
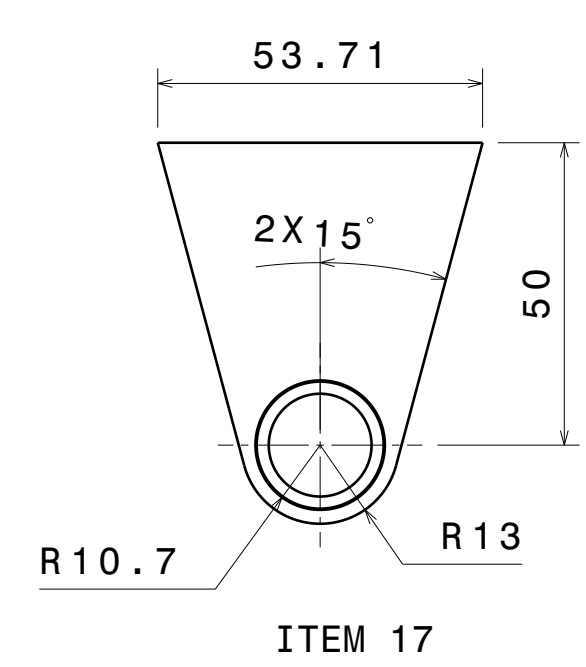
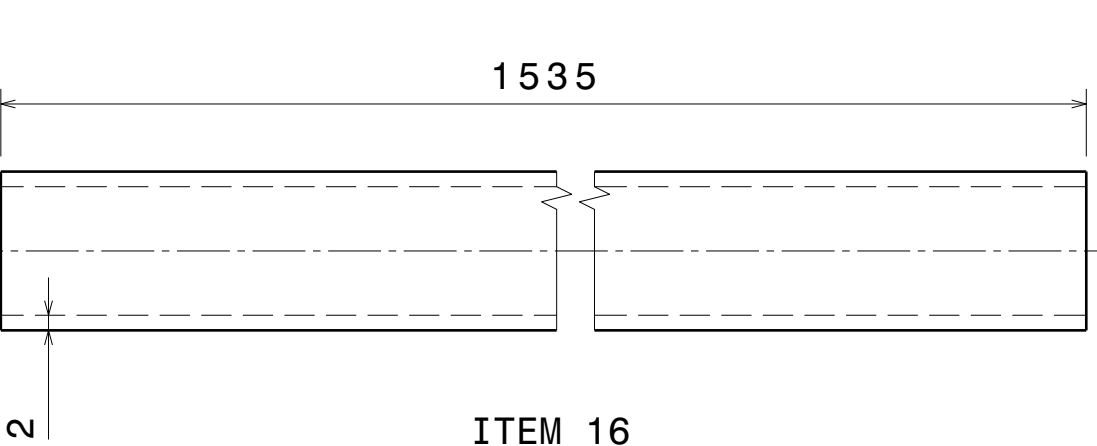
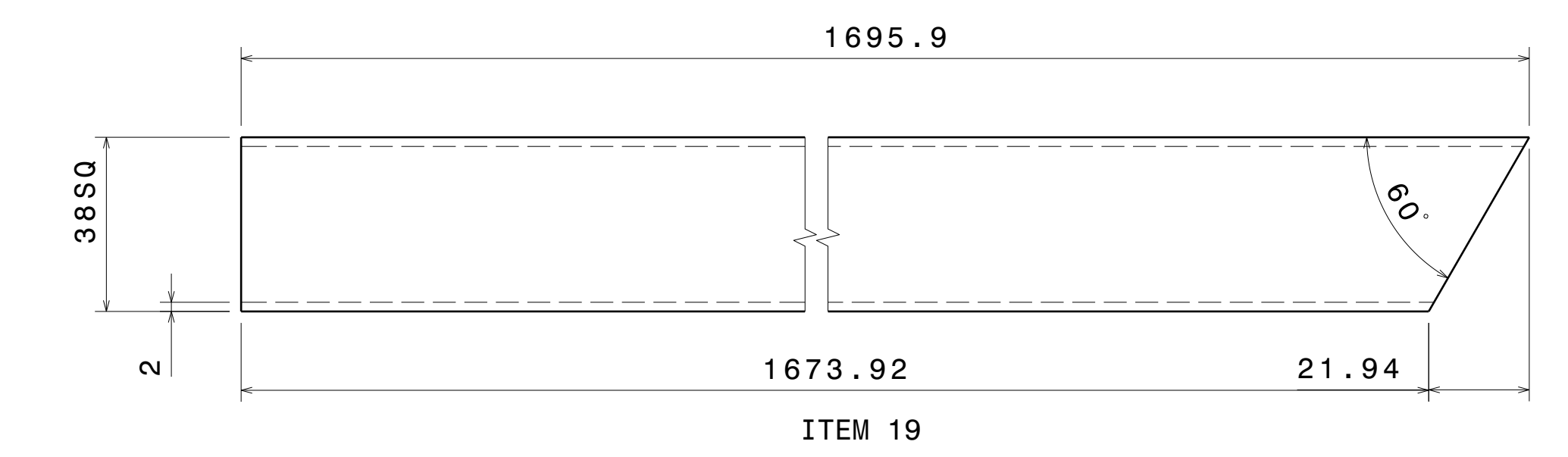
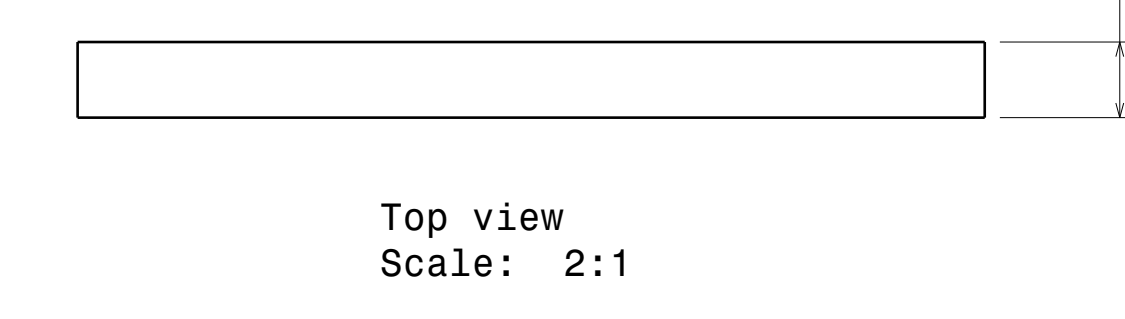
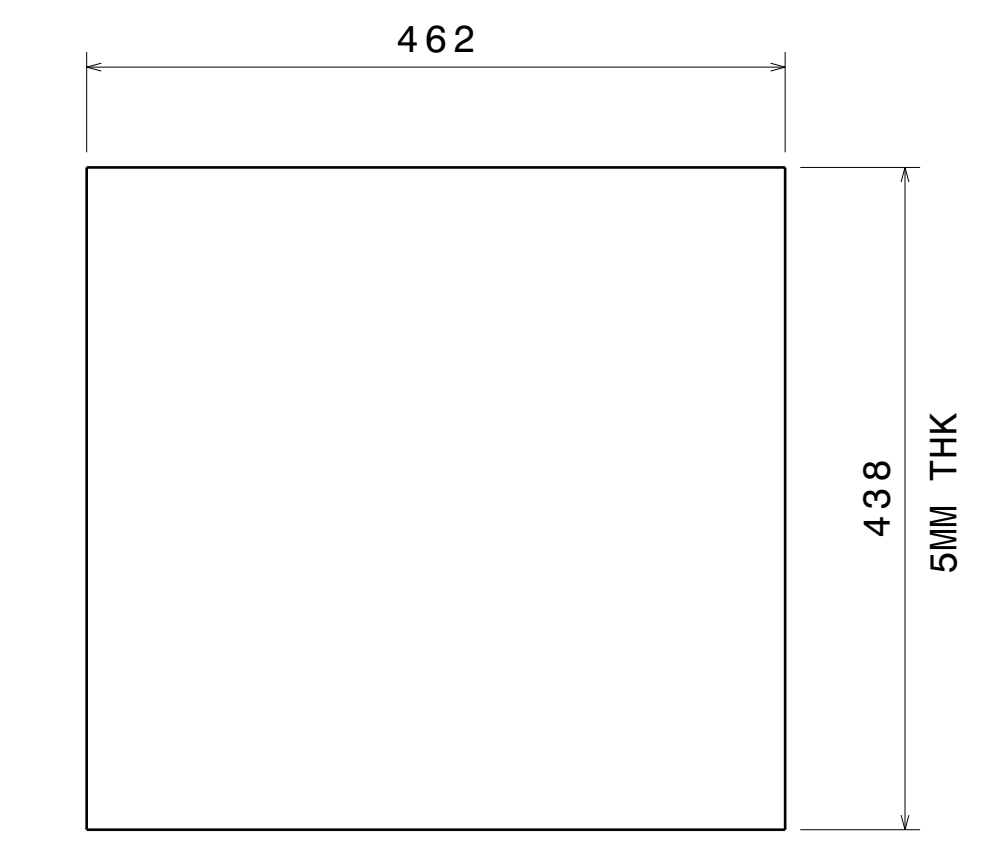
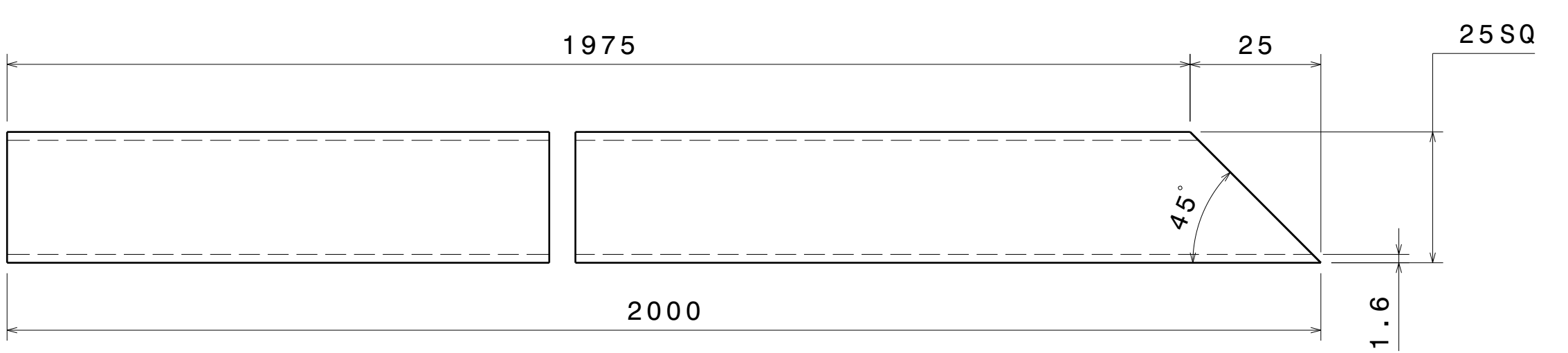
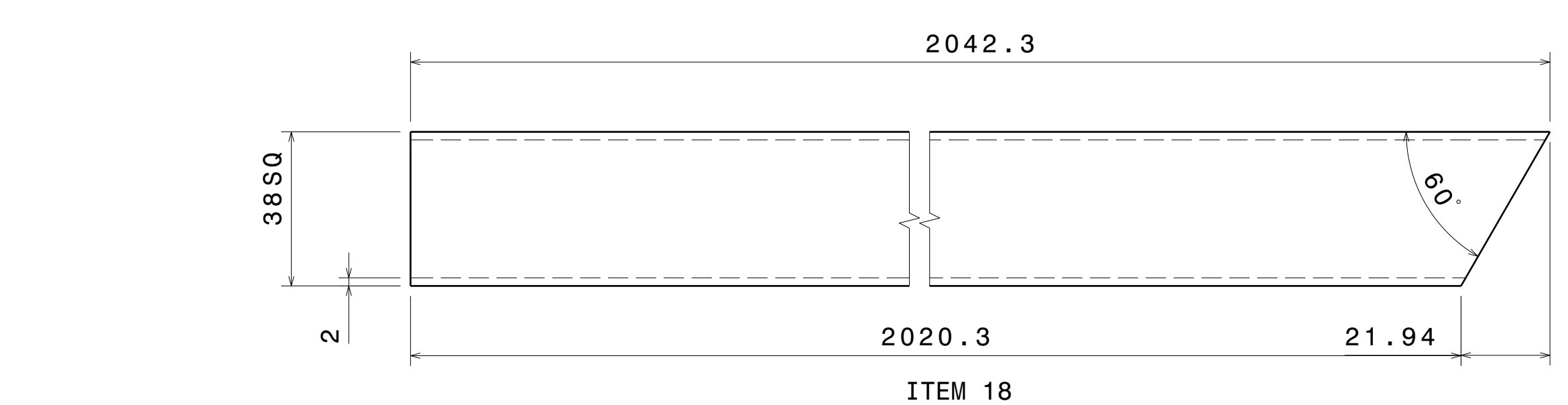
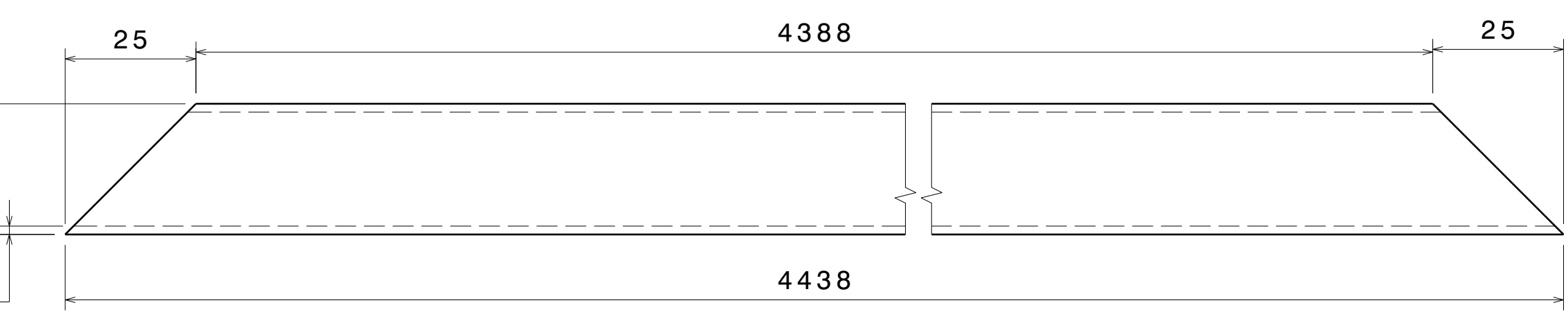
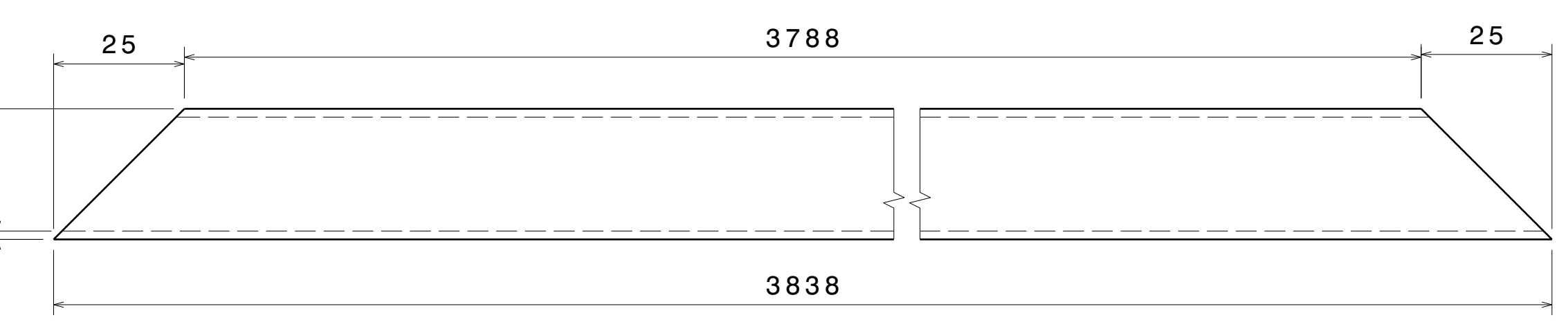
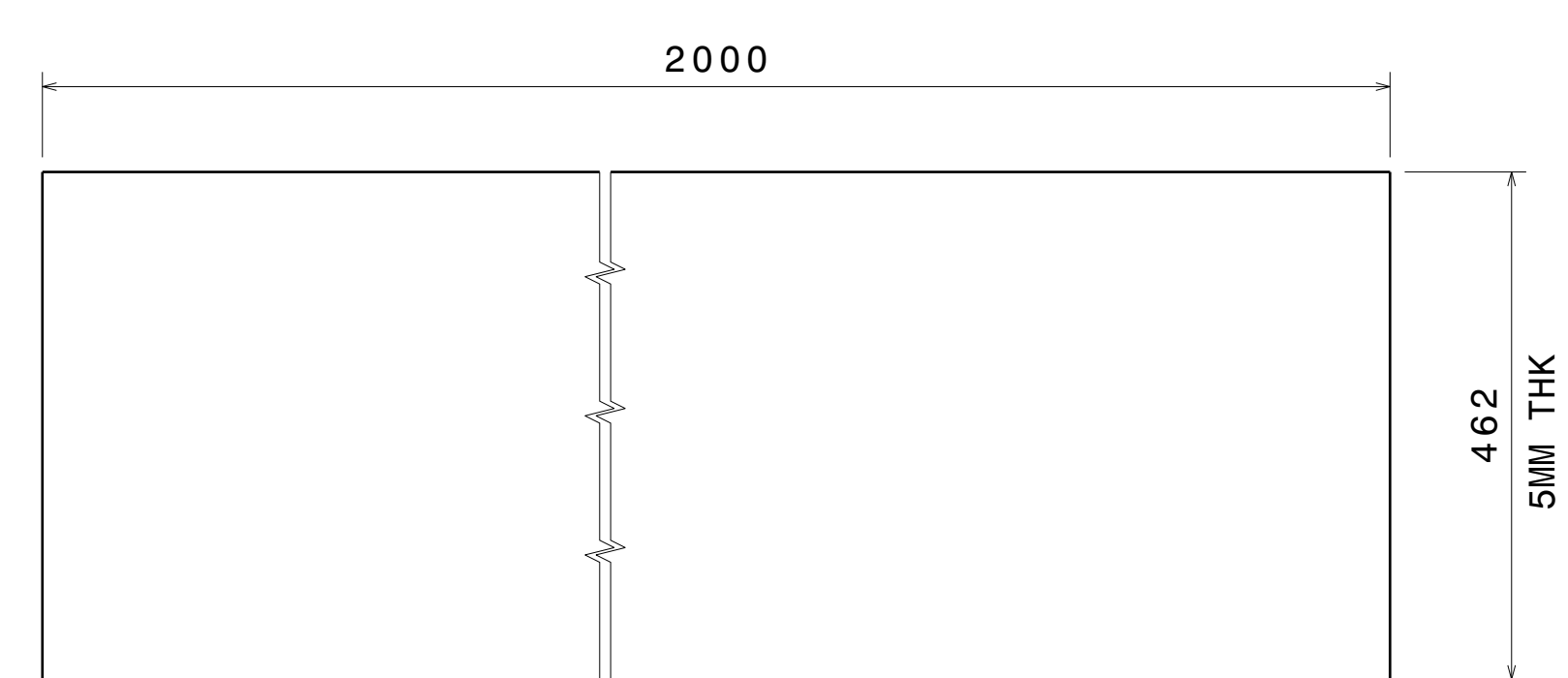
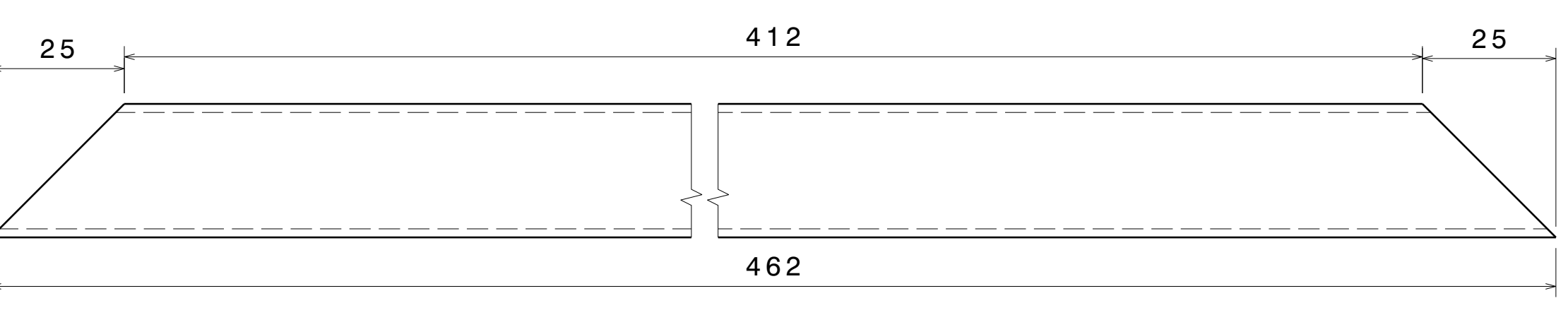
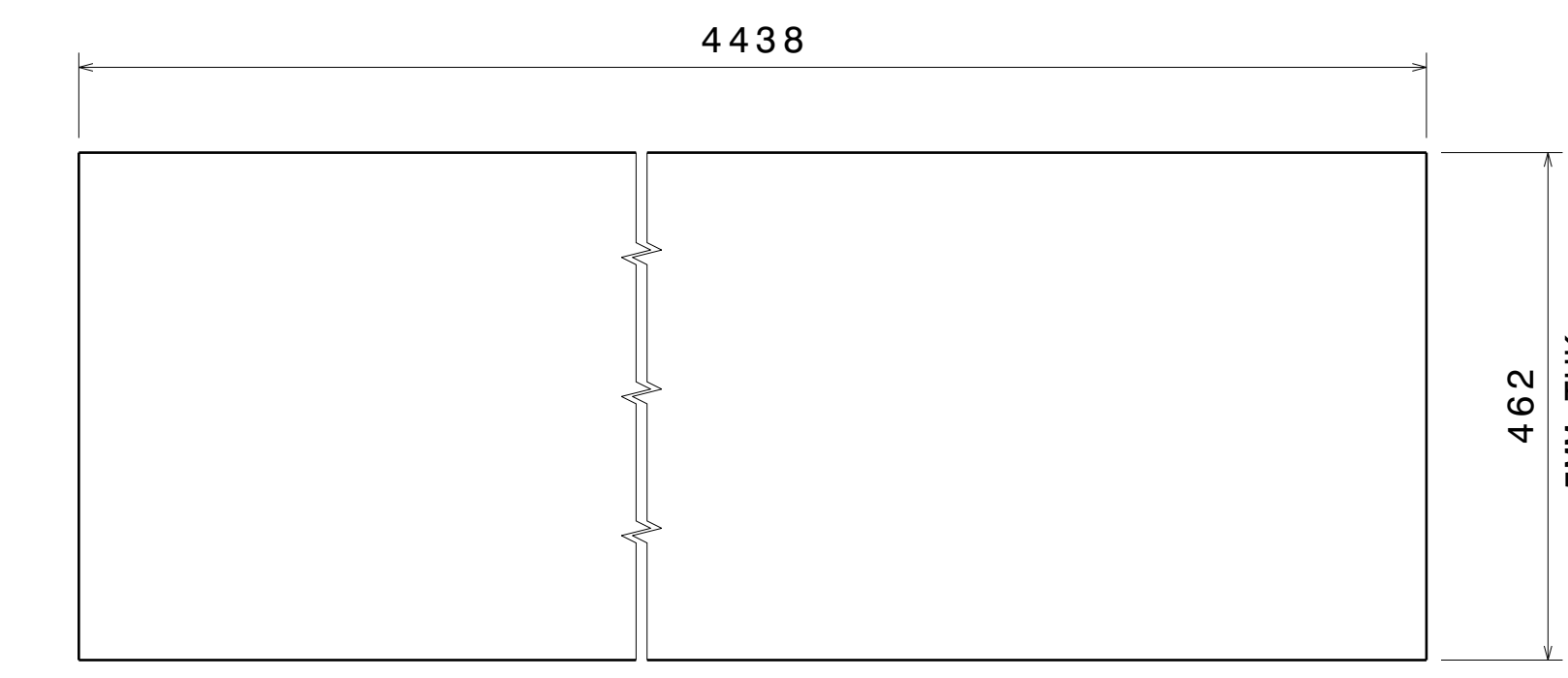
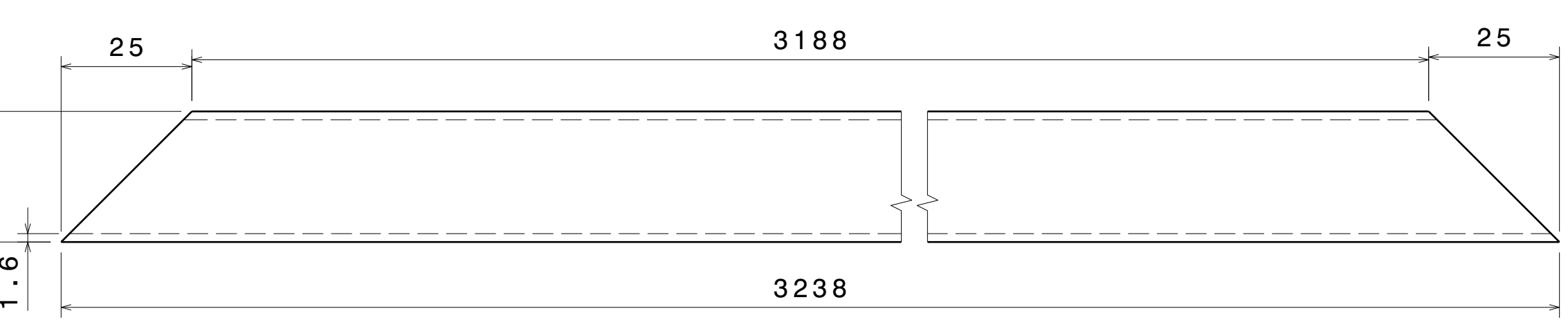
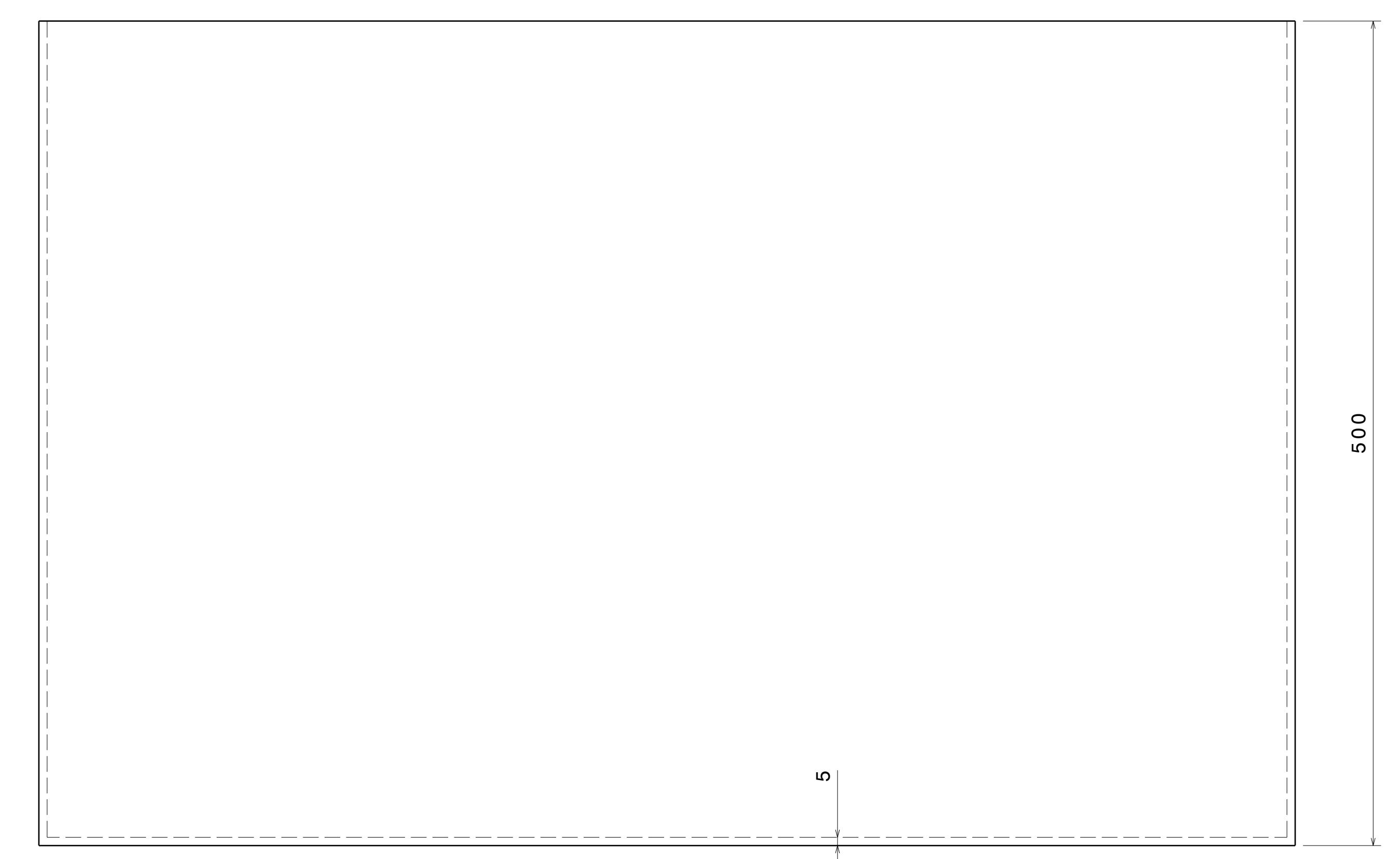
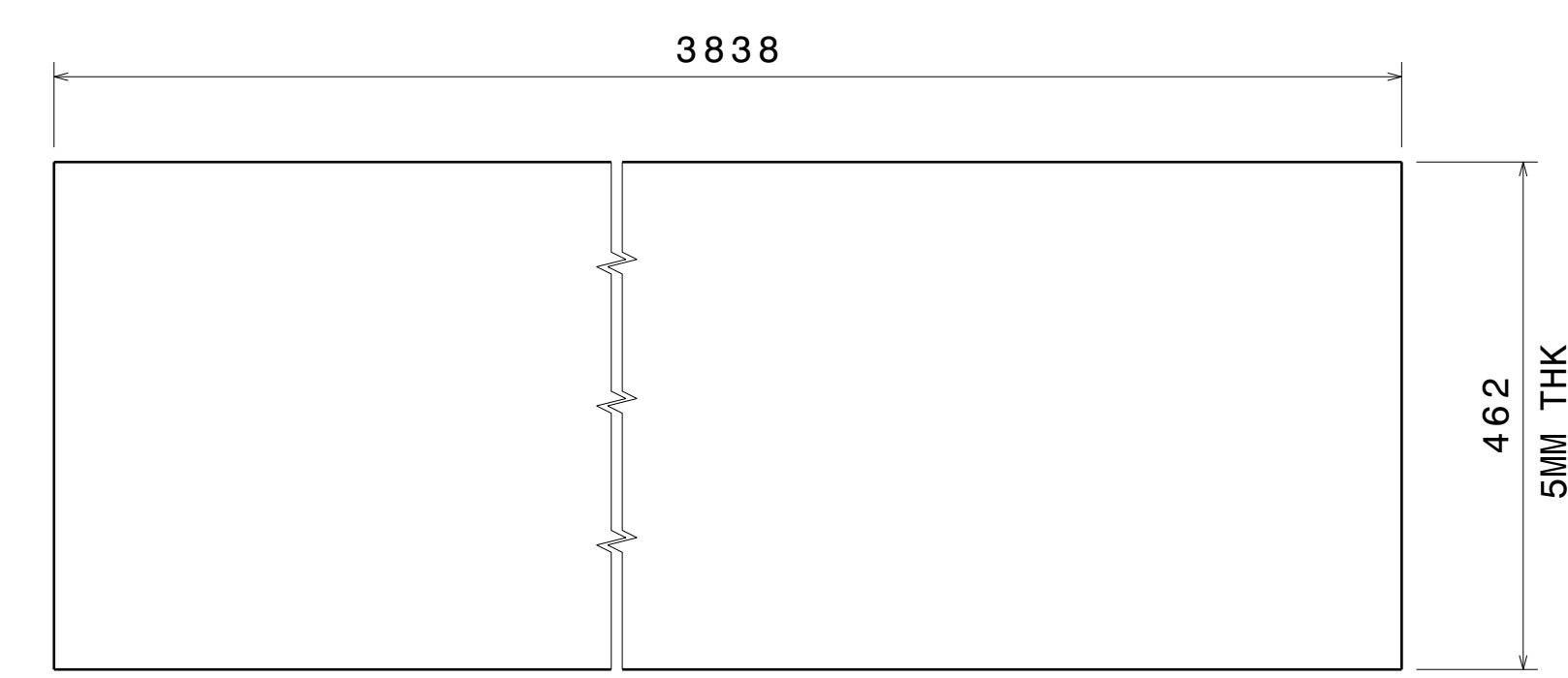
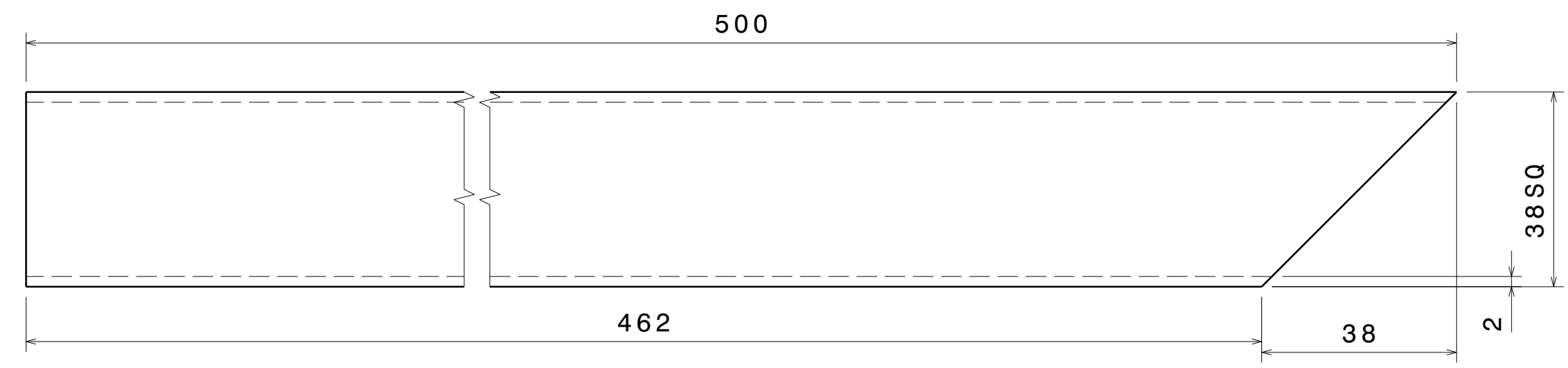
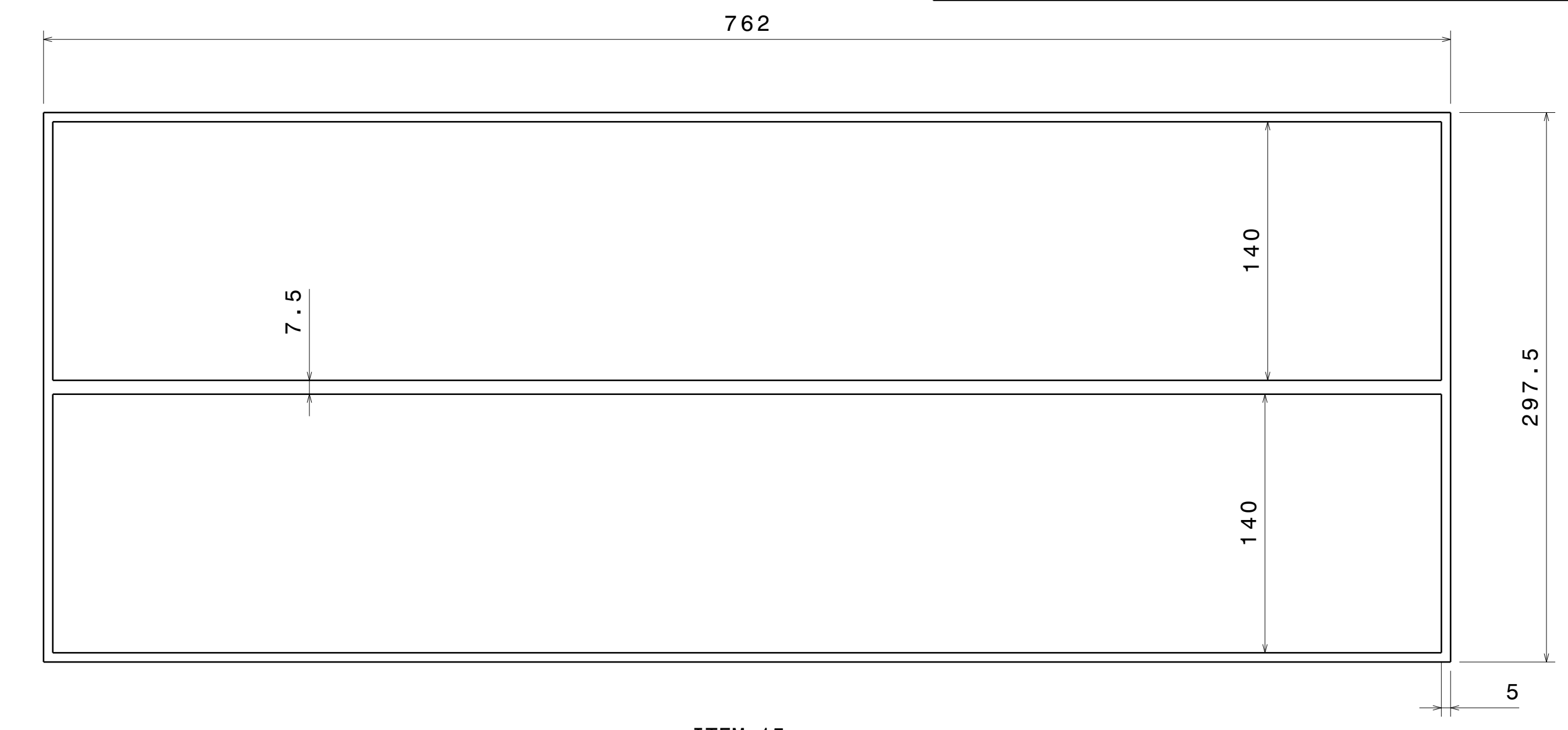
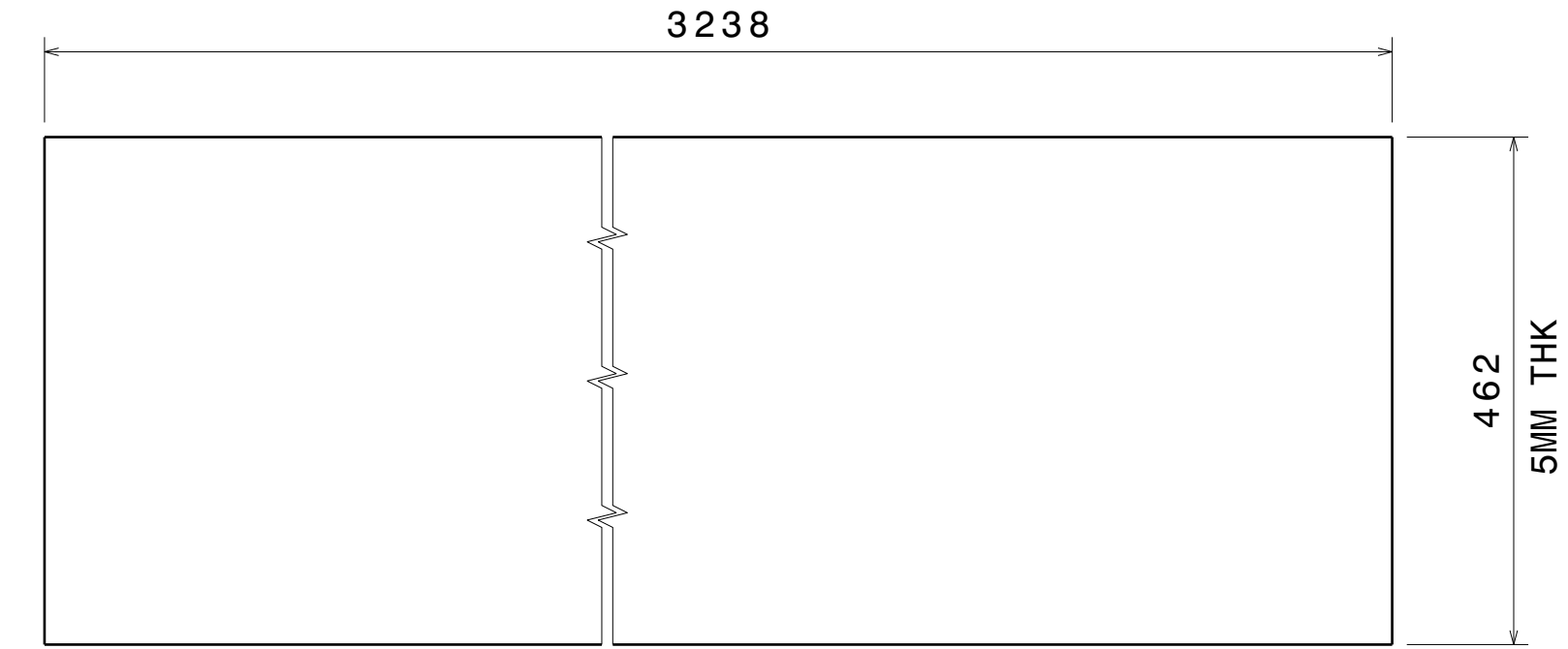
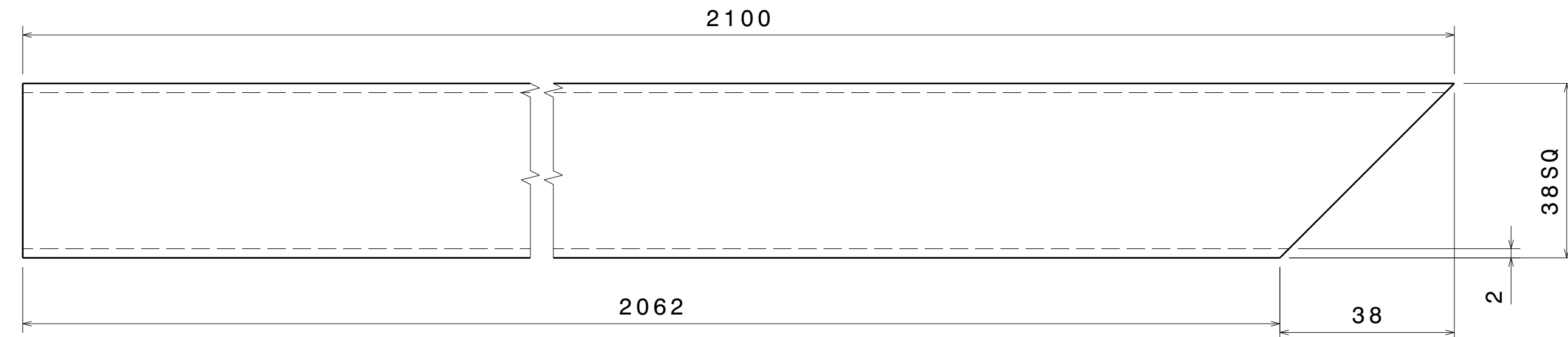

UNLESS OTHERWISE SPECIFIED DIMENSION ARE IN MM VIEWS: THIRD ANGLE PROJECTION

This drawing is our property. It can't be reproduced or communicated without our written agreement.

DRAWN BY		DATE		DRAWING TITLE	
SB		16JUN2020		May 19	
CHECKED BY		DATE		SIZE	DRAWING NUMBER
P2P Analysis & Solutions		16JUN2020		A0	P2P May 19
DESIGNED BY		DATE		SCALE	WEIGHT (kg)
P2P Analysis & Solutions		16JUN2020		NONE	XXX
				SHEET 3 OF 3	

