

REV	DATE	DESCRIPTION
00	20/04/2020	INITIAL REVISION

NOTES:

1. (⊥) ALL VERTICAL SUPPORTS ARE PERPENDICULAR.
2. □ FLATNESS OF .5MM IS APPLIED BY DEFAULT.
3. ∇ WELD BEAD OF 2MM RADIUS IS FOLLOWED.
4. ∇∇ SURFACE FINISH MEDIUM TO SMOOTH IS USED.
5. ALL TUBES ARE AS PER APL APOLLO STANDARD. CHANGES MAY EFFECT THE LOAD CAPACITY.
6. ALL HORIZONTAL AND VERTICAL TUBES ARE PERPENDICULAR TO EACH OTHER WITH ±1 DEG.
7. FINE WELDING IS REQUIRED AS PER MENTIONED DETAILS AND FINISHING.
8. HIGHER CURRENT WELDING MAY AFFECT THE BRITTLENESS OF MATERIAL WHICH LATER MAY RAISE TO WEAKENING OF STRUCTURE.
9. FABRICATORS ARE ALLOWED TO USE FITTINGS/FRAMES/SUPPORTS AS NEEDED AND THE SAME MUST BE COMMUNICATED BACK TO ENGINEERING TEAM.
10. LENGTH OF ALL LONGITUDINAL FRAMES ARE FOR REFERENCE ONLY AND SUBJECTED TO CHANGE PER REQUIREMENT.

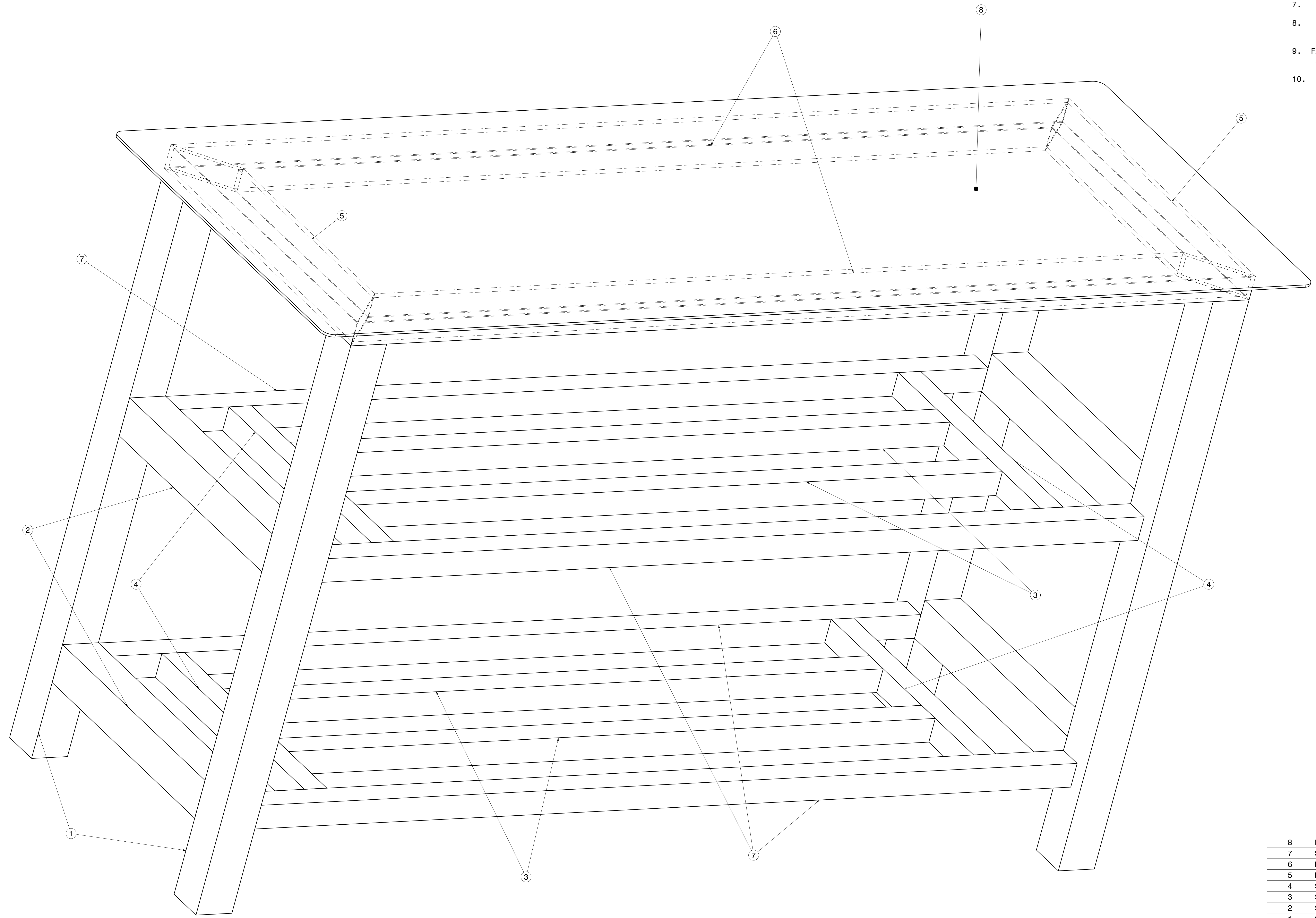

Isometric view
Scale: 7:10

ITEM NO.	PART NUMBER	DESCRIPTION	QTY.	Wt (Kg) / Each
8	Plate -BOP	1100 X 390, T=2.5	1	8.4
7	Sq Tube Shoe Bench 2 Frame 7	25 X 25 X 2.6 X 920	4	1.7
6	Rect Tube Shoe Bench 2 Frame 6	50 X 25 X 2.6 X 1000	2	2.6
5	Rect Tube Shoe Bench 2 Frame 5	50 X 25 X 2.6 X 340	2	0.8
4	Sq Tube Shoe Bench 2 Frame 4	25 X 25 X 2.6 X 260	4	0.5
3	Sq Tube Shoe Bench 2 Frame 3	25 X 25 X 2.6 X 720	4	1.3
2	Sq Tube Shoe Bench 2 Frame 2	40 X 40 X 3.2 X 260	4	1
1	Sq Tube Shoe Bench 2 Frame 1	40 X 40 X 3.2 X 600	4	2.2

This drawing is our property. It can't be reproduced or communicated without our written agreement.

APL APOLLO TUBES LTD.

DRAWING TITLE: **SHOE BENCH 2**

DRAWN BY: SB	DATE: 20/04/2020	CHECKED BY: P2P Analysis & Solutions	DATE: 20/04/2020	DESIGNED BY: P2P Analysis & Solutions	DATE: 20/04/2020	SIZE: A0	DRAWING NUMBER: P2P SHOE BENCH 2	REV: 00
UNLESS OTHERWISE SPECIFIED DIMENSION ARE IN MM		VIEWS: THIRD ANGLE PROJECTION		SCALE: As Indicated		WEIGHT (kg): 0kg		SHEET 1 OF 5

REV	DATE	DESCRIPTION
00	20/04/2020	INITIAL REVISION

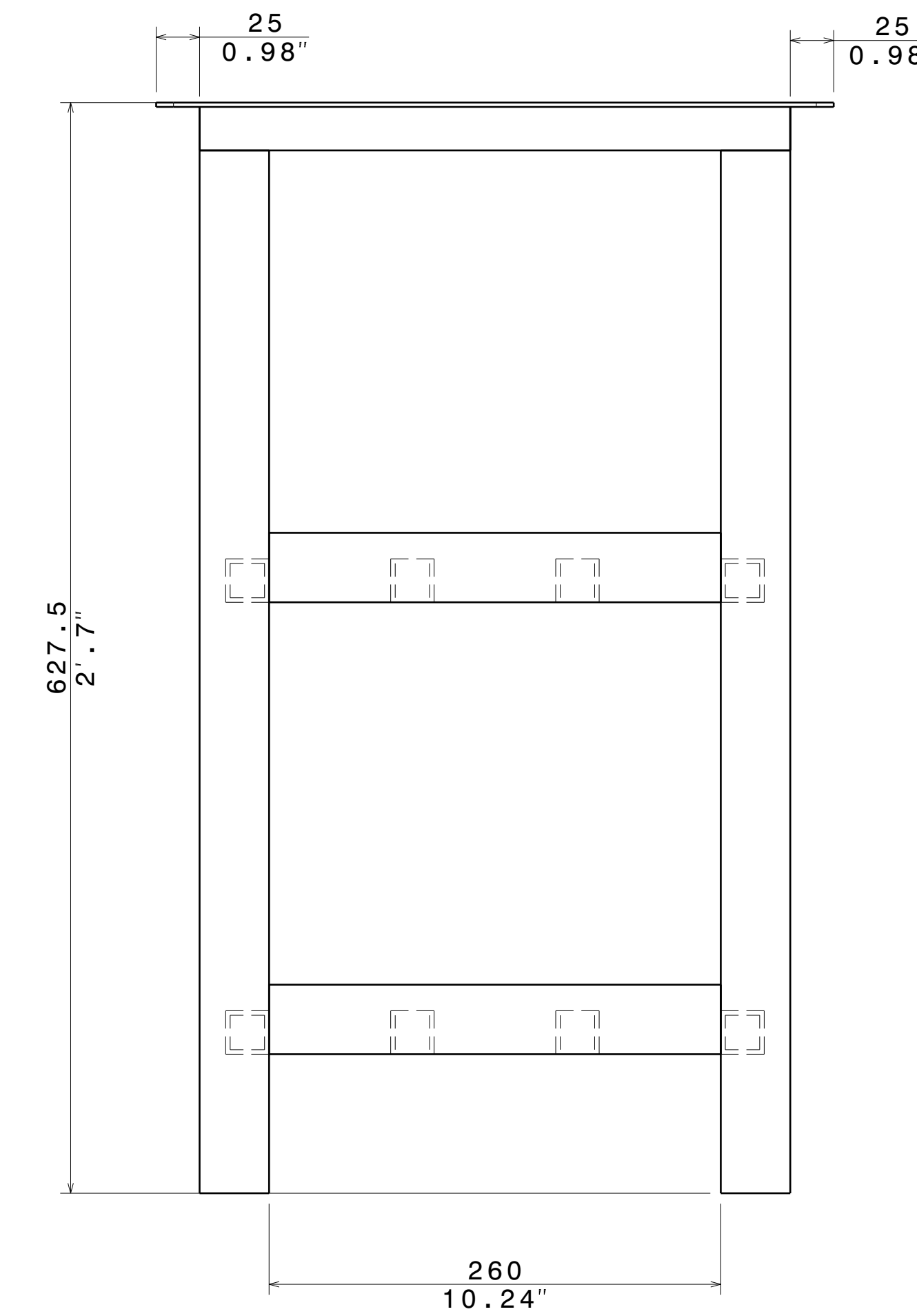
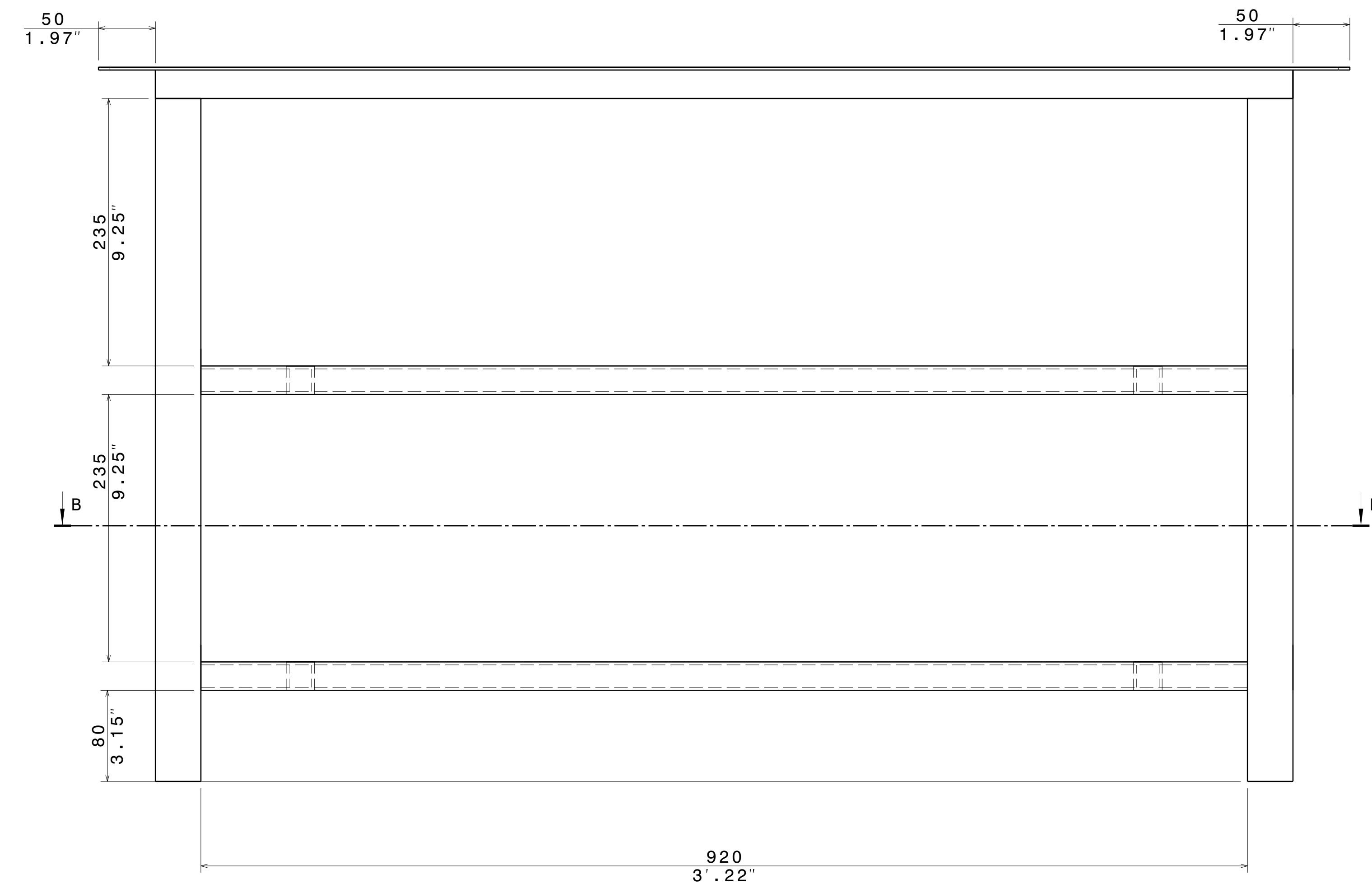
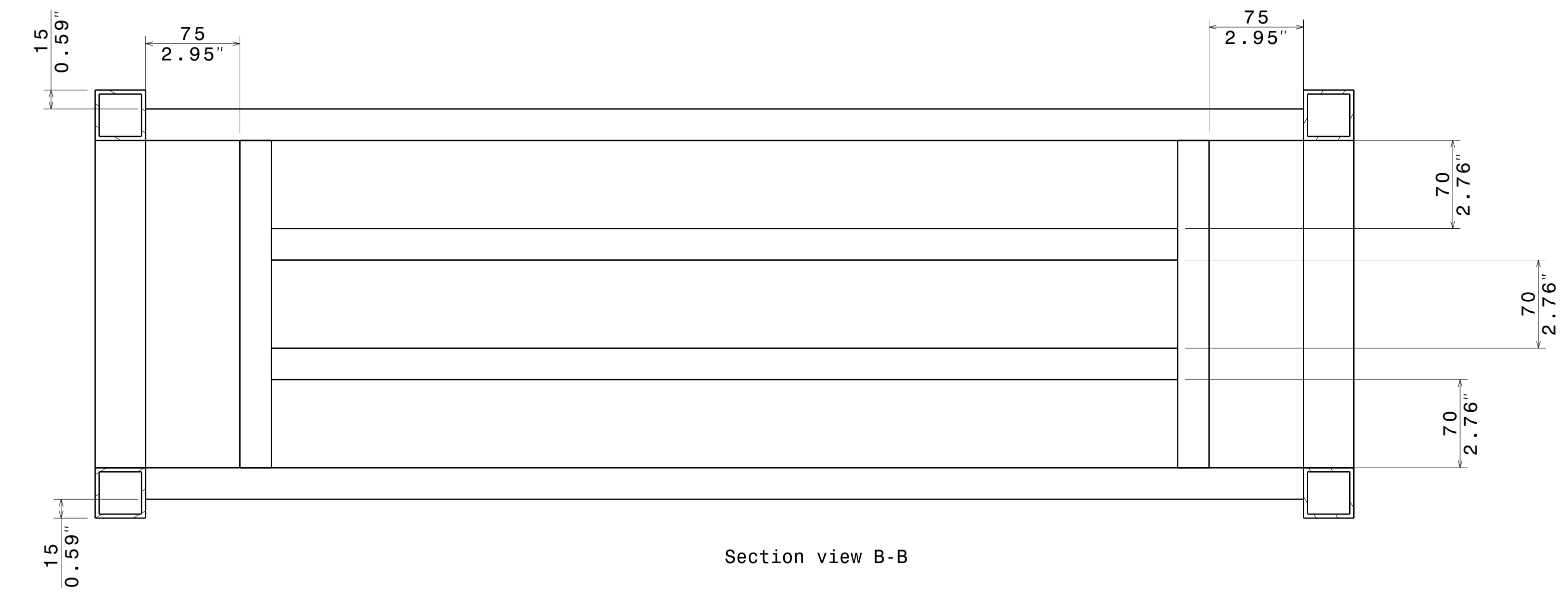
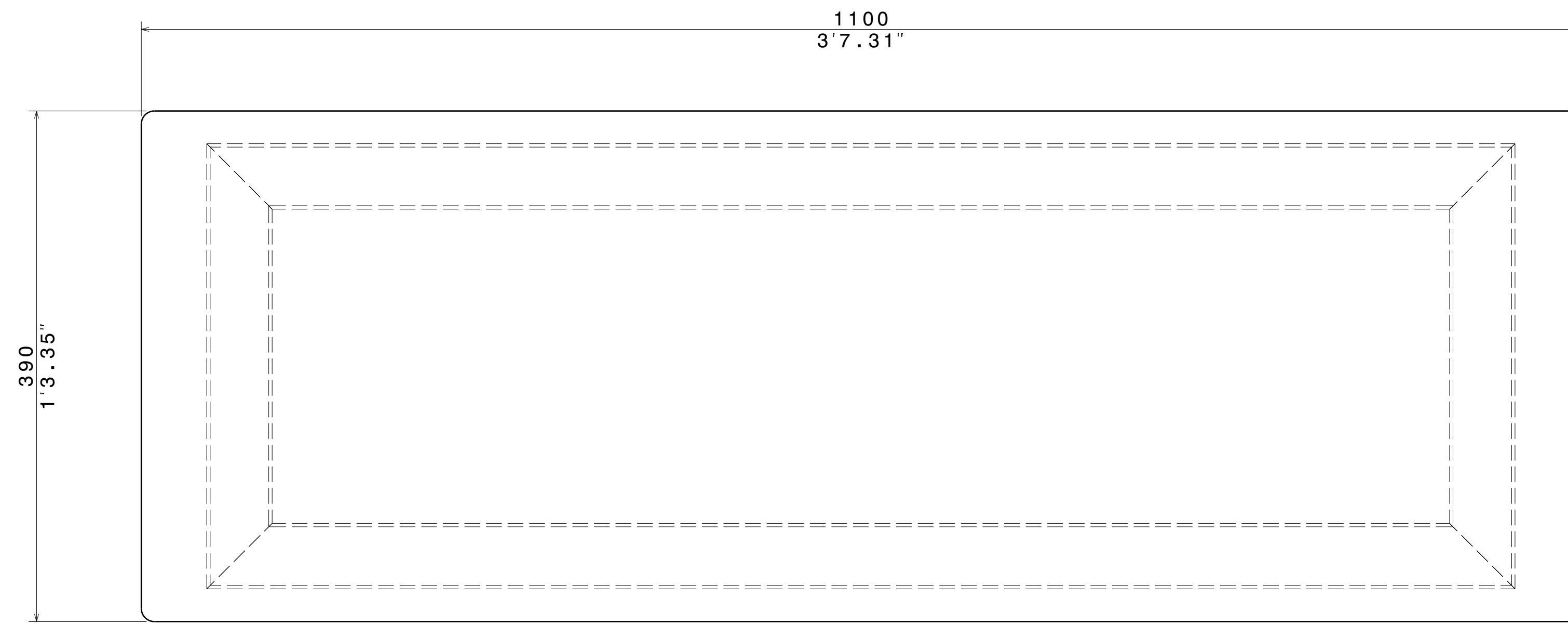

This drawing is our property. It can't be reproduced or communicated without our written agreement.

APL APOLLO TUBES LTD. 

DRAWN BY	DATE
SB	20/04/2020
CHECKED BY	DATE
P2P Analysis & Solutions	20/04/2020
DESIGNED BY	DATE
P2P Analysis & Solutions	20/04/2020

DRAWING TITLE	
SHOE BENCH 2	
SIZE	DRAWING NUMBER
A0	P2P SHOE BENCH 2
SCALE	WEIGHT (kg)
NONE	XXX
REV	SHEET 2 OF 5
00	

UNLESS OTHERWISE SPECIFIED DIMENSION ARE IN MM
 VIEWS: THIRD ANGLE PROJECTION

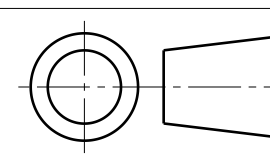

REV	DATE	DESCRIPTION
00	20/04/2020	INITIAL REVISION

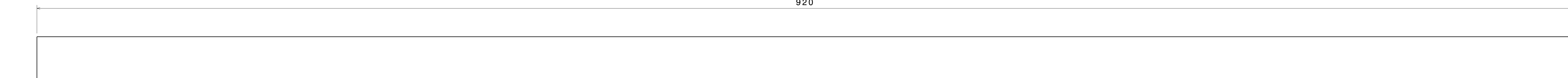

ITEM 7 DETAILS
Sq Tube Shoe Bench 2 Frame 7

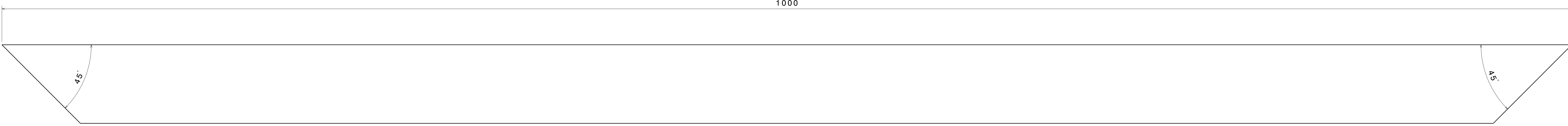

ITEM 6 DETAILS
Rect Tube Shoe Bench 2 Frame 6

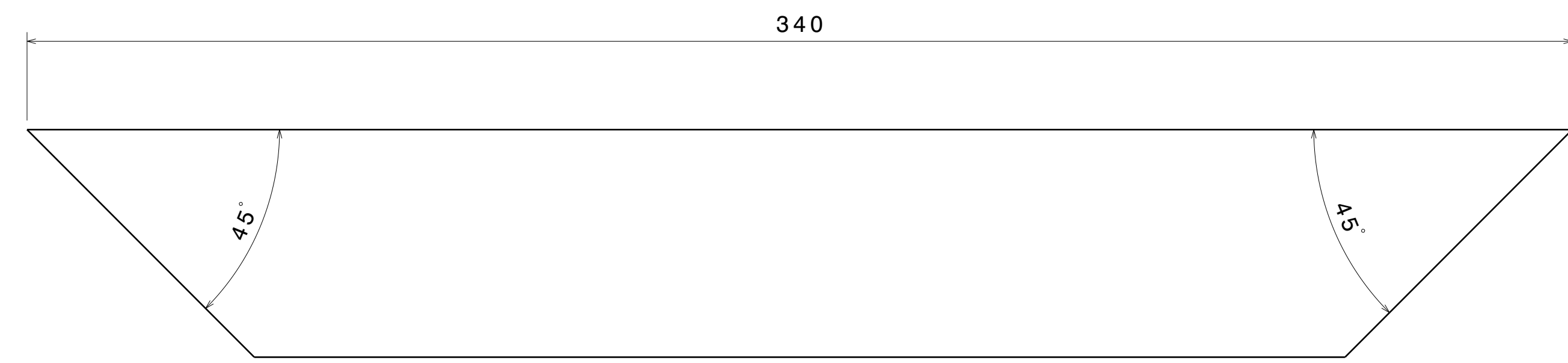

ITEM 5 DETAILS
Rect Tube Shoe Bench 2 Frame 5

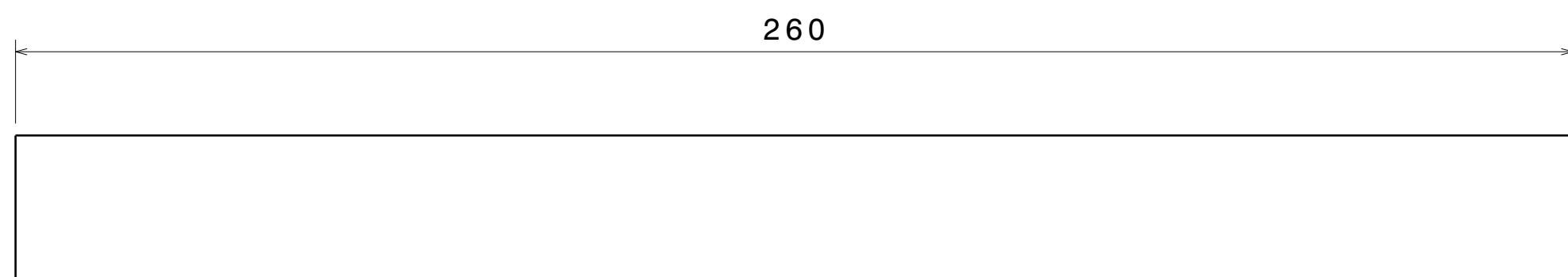

ITEM 4 DETAILS
Sq Tube Shoe Bench 2 Frame 4

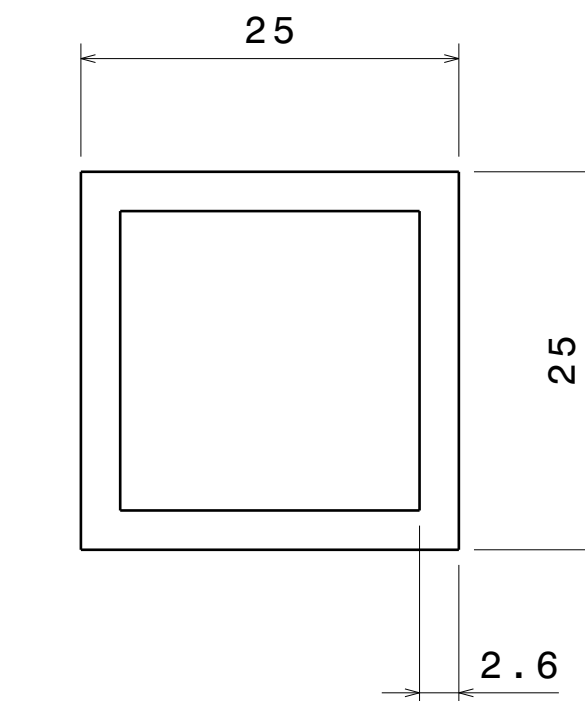

Section Detail of ITEM 3, 4 & 7
Scale: 2:1

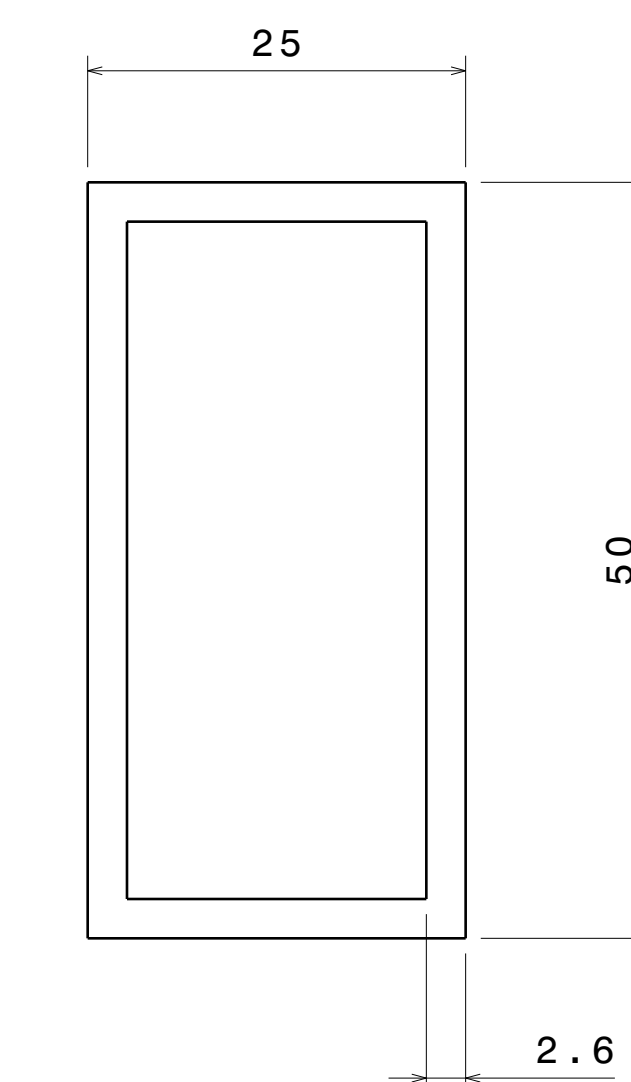

Section Detail of ITEM 5 & 6
Scale: 2:1

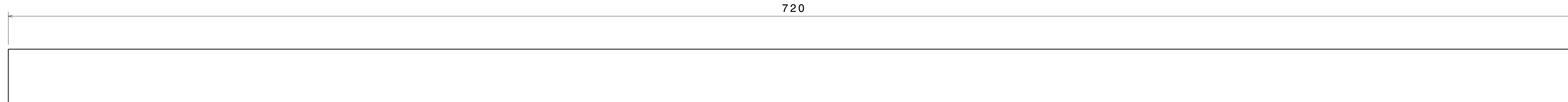

ITEM 3 DETAILS
Sq Tube Shoe Bench 2 Frame 3

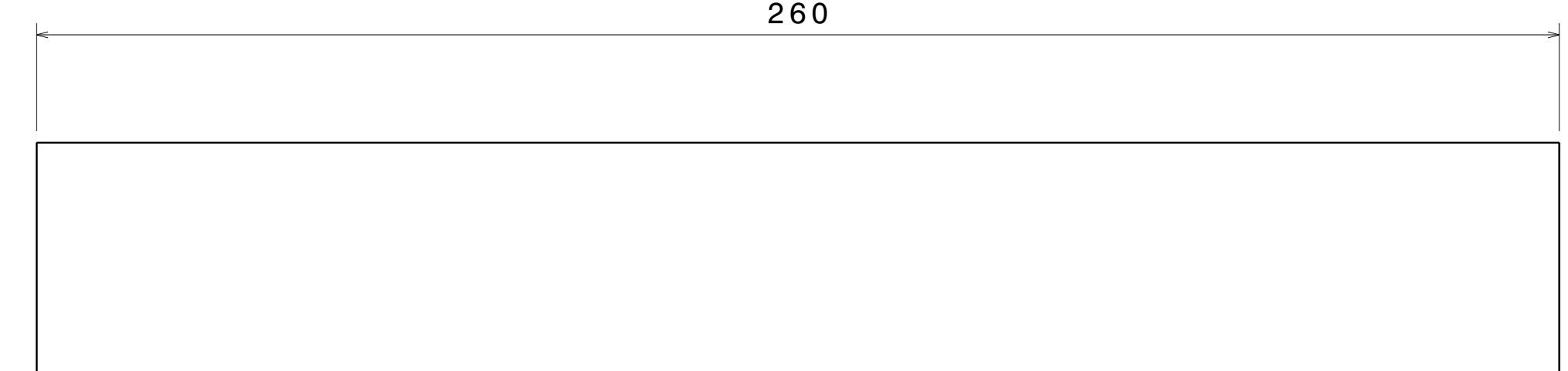

ITEM 2 DETAILS
Sq Tube Shoe Bench 2 Frame 2

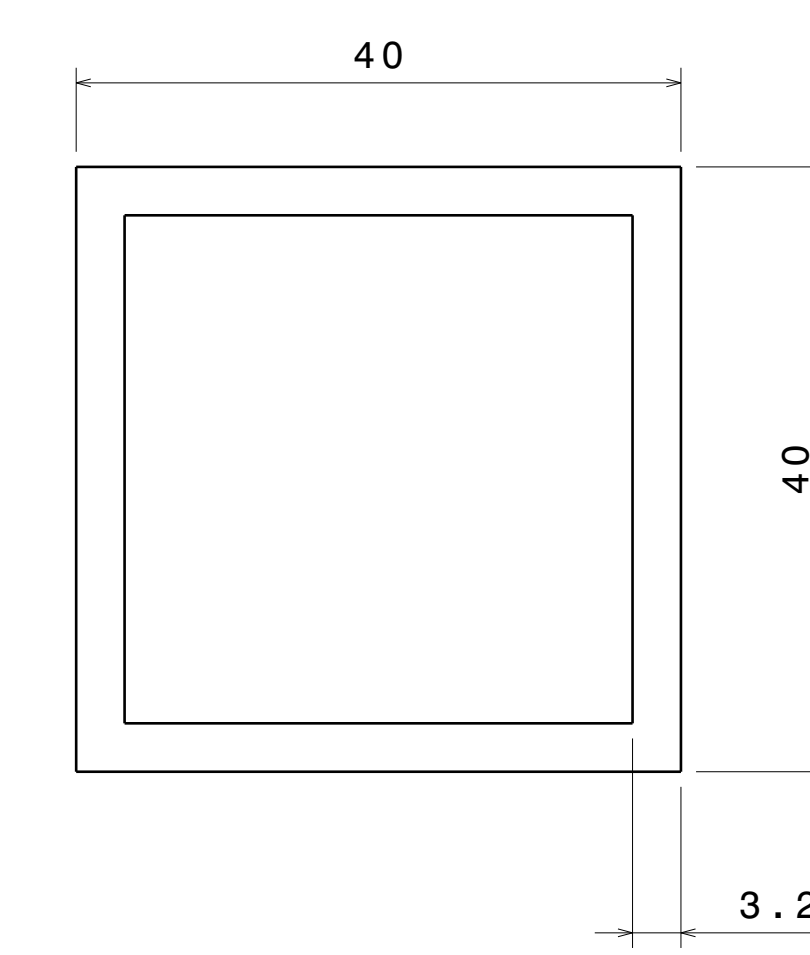

Section Detail of ITEM 1 & 2
Scale: 2:1

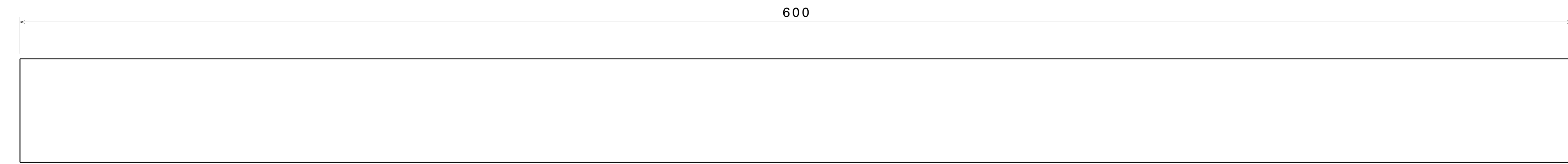

ITEM 1 DETAILS
Sq Tube Shoe Bench 2 Frame 1

UNLESS OTHERWISE SPECIFIED DIMENSION ARE IN MM
VIEWS: THIRD ANGLE PROJECTION

This drawing is our property. It can't be reproduced or communicated without our written agreement.

DRAWN BY	DATE
SB	20/04/2020
CHECKED BY	DATE
P2P Analysis & Solutions	20/04/2020
DESIGNED BY	DATE
P2P Analysis & Solutions	20/04/2020

APL APOLLO TUBES LTD.	
DRAWING TITLE	
SHOE BENCH 2	
SIZE	DRAWING NUMBER
A0	P2P SHOE BENCH 2
SCALE	WEIGHT (kg)
NONE	XXX
REV	SHEET 3 OF 5
00	